

Dan Mc

Ranger[®] BOATS

Sportfisherman Series Owner/ Operator Manual

RECORD IMPORTANT INFORMATION!

Hull

HIN _____

Date Purchased _____

Dealer/Phone _____

Ignition Key Number _____

Registration Number/State _____

Engine

Model # _____

Serial # _____

Engine

Model # _____

Serial # _____

Trailer

Model # _____

Serial # _____

Accessory

Model # _____

Serial # _____

INTRODUCTION

Take a few minutes to read this manual completely before you use your boat for the first time, it should answer any remaining questions you may have. Contact your dealer or local boating administrator for further information.

Because of our policy of continuous product improvement, the illustrations used in this manual may not be the same as on your boat and are intended only as representative reference views. Keep this manual on board for future reference.

IDENTIFICATION NUMBERS

Safeguard information about your boat by recording the Hull Identification Number (HIN) and model of your boat, and model and serial numbers of the engine and accessories on the inside front cover of this manual. The HIN is located on the upper, starboard corner of the transom. The HIN must be clearly visible and may not be removed, altered or tampered with in any way by federal law.

The identification numbers are important! Keep a copy of these numbers stored in a safe place off the boat. In case of theft, damage, etc., report these numbers to the local authorities, your insurance agent and your dealer.

BOATING TERMINOLOGY

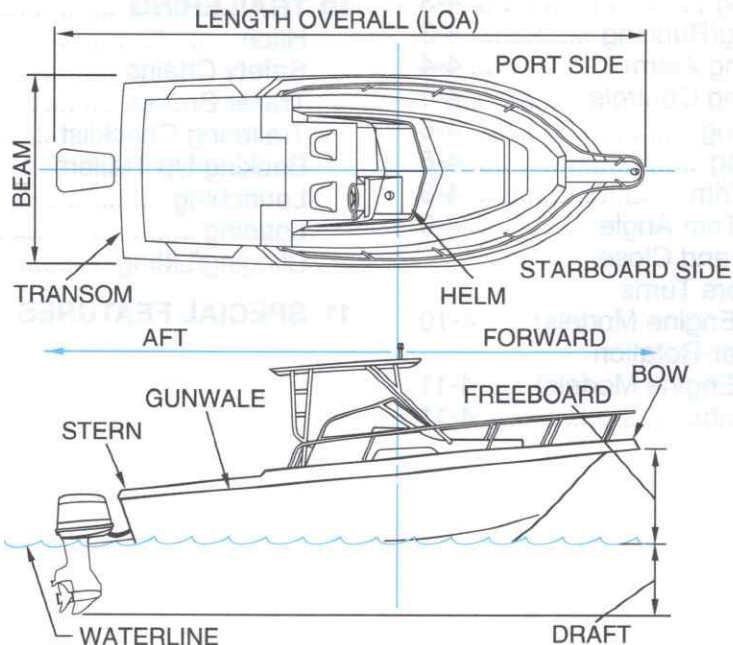

KC-0038

TABLE OF CONTENTS

	Page		Page
1 BOATING SAFETY	1-1	5 GETTING UNDERWAY ...	5-1
Boating Regulations	1-2	Safety Checklist	5-1
Boater Responsibilities	1-2	Safety Equipment	5-3
Emergencies	1-5	Boarding	5-3
Hazardous Conditions	1-6	6 RUNNING	6-1
Operation By Minors	1-10	Maneuvering Techniques .	6-1
Passenger Safety	1-10	Salt Water	6-3
Water Sports	1-11	Freezing Temperatures	6-3
General Precautions	1-13	Towing Procedure	6-3
2 BASIC RULES		Anchoring	6-4
OF THE ROAD	2-1	Propellers	6-5
Aids to Navigation	2-1	7 CARE AND	
Right-of-Way	2-4	MAINTENANCE	7-1
3 CONTROLS AND		Electrical	7-1
INDICATORS	3-1	Corrosion Protection	7-4
Shift/Throttle Control	3-1	General Maintenance	7-5
Instruments	3-2	Fuel System	7-7
Hydraulic Steering		Steering System	7-8
System	3-8	8 TROUBLESHOOTING	8-1
4 OPERATION	4-1	Trouble Check Chart	8-1
Fueling	4-1	9 STORAGE	9-1
Lubrication (Outboards) ...	4-2	10 TRAILERING	10-1
Starting	4-3	Hitch	10-2
Shifting/Running	4-3	Safety Chains	10-2
Warning Alarm	4-4	Trailer Brakes	10-3
Steering Controls	4-4	Trailering Checklist	10-3
Stopping	4-6	Backing Up Trailers	10-5
Docking	4-6	Launching	10-5
Boat Trim	4-8	Loading	10-6
Drive Trim Angle	4-9	Slinging/Lifting	10-7
Sharp and Close		11 SPECIAL FEATURES	11-1
Quarters Turns			
(Twin Engine Models)	4-10		
Counter-Rotation			
(Twin Engine Models)	4-11		
Trim Tabs	4-11		



BOATING SAFETY

The popularity of boating and other water sports has undergone an explosion of growth in the past few years. Because of this, safety is an important issue for everyone who shares in the use of our waterways.

This section covers general boating safety information. Throughout this manual specific precautions and symbols identify safety related information.



The Safety Alert Symbol means **ATTENTION! BECOME ALERT! YOUR SAFETY IS INVOLVED!**



WARNING



This symbol and signal word indicate a potentially hazardous situation which, if not avoided, **COULD** result in death or serious injury.



CAUTION

This symbol and signal word indicate a potentially hazardous situation which, if not avoided, **MAY** result in minor or moderate injury. This symbol **MAY** also be used to alert against unsafe practices.

CAUTION

This signal word indicates a situation which if not avoided, **MAY** result in product or property damage.

The precautions listed in this manual and on the boat are not all-inclusive. If a procedure, method, tool or part is not specifically recommended, you must satisfy yourself that it is safe for you and others, and that the boat will not be damaged or made unsafe as a result of your decision. **REMEMBER – ALWAYS USE COMMON SENSE WHEN OPERATING!**

BOATING REGULATIONS

The U.S. Coast Guard is the authority of the waterways; they are there to help the boating public. State boating regulations are enforced by local authorities. You are subject to marine traffic laws and "Rules of the Road" for both federal and state waterways; you must stop if signaled to do so by enforcement officers, and permit to be boarded if asked.

There are many pamphlets, prepared by the Coast Guard, available to you. These pamphlets explain "Rules of the Road", signal lights, buoys, safety, international and inland regulations and much more than is presented in this manual. For more information contact your local U.S. Coast Guard Unit or call the Coast Guard Boating Safety Hotline at 1-800-368-5647.

BOATER RESPONSIBILITIES

Registration

The U.S. Coast Guard requires that all power boats operated on the navigable waters of the United States must be registered in the state of main use; also, many States require registration in that state whenever boating on waters within their state boundary. Always contact your state boating authorities (and neighboring states) for registration information on boats and trailers. Your dealer may be able to supply you with the appropriate forms.

Education

This manual is not intended to provide complete training on all aspects of boat operation. We strongly recommend that all operators of this boat seek additional training on boat handling and safety. Many states require operators under the age of 18 to be licensed in small boat operation and offer courses for training and certification.

The following is a listing of some of the agencies and organizations that offer safety training or information; refer to your local telephone directory for their telephone numbers and addresses.

- American Red Cross
- U.S. Coast Guard Auxiliary
- National Fish and Wild Life Foundation
- U.S. Power Squadrons
- State Boating Offices
- Sport Fishing Institute

Insurance

You must get insurance before operating your new boat. Loss by fire, theft or other causes, or liability protection against accidents is a must for responsible boaters. The boat owner is legally responsible for any damage or injury caused when he, or someone else operating the boat, is involved in an accident. Many states have laws detailing minimum insurance needs. Your insurance agent or your dealer may be able to supply you with more information.

BOATING SAFETY



Required Safety Equipment

Your boat has been equipped at the factory with most federally required (Class 1, 16' to 26') safety equipment for **inland** waters.

Federal law also requires at least one Type I, II or III Personal Flotation Device (PFD) for each person on board or being towed on water skis; and in addition, one throwable Type IV PFD. **As the owner, obtaining PFDs and other necessary safety equipment is your responsibility.**

Note

Requirements for coastal waters and inland waters differ; check with the local authorities for more information.

PFDs are intended to help you save your own life; you and your passengers should wear a PFD whenever boating. It is especially important that children or non-swimmers wear a PFD at all times. Make certain you know how to use PFDs. Try it on and make adjustments for a comfortable fit. Show children how to properly put on a PFD. There are three types of acceptable PFDs to wear and one type used for throwing in emergency situations.

Note

For coastal waters a Type I PFD should be used because it provides the most protection to its wearer, especially during offshore and ocean cruising.

Type I – good for off-shore or rough water use.

Type II – good for near-shore and most inland waters.

Type III – good for calm, inland waters. Type III PFDs are recommended for continuous use.

Type IV – designed to be thrown to person in the water. They are easy to hang on to in the water but do not protect as well as Types I, II or III. **Cushions should never be worn on a person's back and must always be kept handy for emergency situations.**



TYPE I
LIFE PRESERVERS

KC-0041



TYPE II
BUOYANT VESTS

KC-0051



TYPE III
FLOTATION AIDS

KC-0061

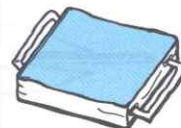
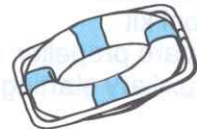

TYPE IV
THROWABLE DEVICES

KC-0071

Note

Special PFDs are available for skiing and other water sports. These PFDs are constructed with materials suitable for high impact falls into the water.

Keep the following PFD points in mind:

- Set an example and wear your PFD. Require your passengers to wear them also.
- Make sure the PFD fits properly; this is especially important for children and non-swimmers.
- At the beginning of each season, check PFDs for damage and test for proper flotation.

Federal law also requires a USCG approved Sight Signaling Device on boats 16' and longer operating on the Great Lakes or coastal waters. The type of device is dependent on the size of the boat and if it is used during the day or night. Your dealer or the Coast Guard can provide you with more information.

Note

Some signaling devices (pyrotechnics) are restricted from use on certain bodies of water, so always check with local authorities.

Recommended Equipment

As a precaution, a good boater will avoid potential problems on an outing by having additional equipment on board. Normally, this equipment is dependent on the body of water and the length of the trip, your dealer can assist you:

- First aid kit and manual
- Anchor with sufficient line
- Sea anchor
- Mooring lines and fenders
- Toe line
- Bailing device (bucket, hand pump, etc.)
- Combination oar/boat hook
- Day/night visual distress signal
- Lubricant
- Tool kit
- Spare propeller, nut and washer
- Auxiliary starting battery and bulbs
- Spare fuses
- Local charts and compass
- Waterproof flashlight
- VHF marine radio
- Portable AM/FM radio with weather band
- Extra keys
- Spare flashlight and radio batteries
- Extra drain plug
- Sunglasses and sun block
- Insect repellent
- Food and water provisions

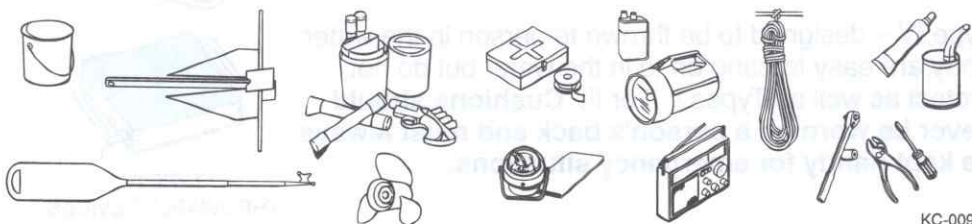

KC-0091

BOATING SAFETY



Note

When fishing offshore it is always a good idea to have an auxiliary engine for emergency power or trolling.

EMERGENCIES

Be prepared to deal with emergencies before they happen. Try to formulate a plan for each type in advance so that decisions can be made quickly and without hesitation. Precious moments lost can mean the difference between losing and saving a life.

Reporting

The operator of the boat is responsible for filing a report with the appropriate authorities. In general, reports are necessary for accidents involving loss of life, injury, or damage over \$200. Ask your insurance agent for detailed information.

Giving Assistance

If you see a distress signal, you must assume it is a real emergency and render assistance immediately. If you can assist a boat in distress, you should. An unwritten law of the sea is that one boater will aid another boater in distress. The 1971 Boating Safety Act grants protection to a “Good Samaritan” boater offering good faith assistance, and absolves a boater from any civil liability arising from assistance given.

Fires

Most fires are the result of gasoline and oil accumulating in the bilge from careless fueling practices. Use the fire extinguisher at the **base of the flames** using a sweeping motion. Prudent and accurate use of the available chemicals should contain all but the worst fires. Verify that the fire has been extinguished. If so, check damage and get assistance immediately. **If not, get out and swim at least 25 yards upwind from the boat and use the visual distress signals to get assistance.**

On board fires involving the fuel system usually result in either an explosion that completely destroys the boat, or the boat burning to the waterline and self extinguishing. Deciding on abandoning the boat or staying to fight the fire is difficult and depends on many factors. **Try to formulate a fire plan in advance to make that decision quickly and without hesitation.**



KC-0163



WARNING



Gasoline will float on top of water and can burn. If the boat is abandoned, swim up wind, far enough to avoid fuel that may spread over the surface of the water to avoid serious injury.

Capsizing

A boat may capsize or swamp when least expected. Like fires, try to formulate a plan in advance on what to do if it should happen. Keep in mind the following guidelines:

- Try to turn the engine OFF to prevent damage.
- If others were on board, try to locate them, make sure they're conscious and that they can swim.
- **Stay with the boat, it will float!** Climb up on the hull and try to get assistance.
- Don't try to swim to shore. It's usually further than it looks.

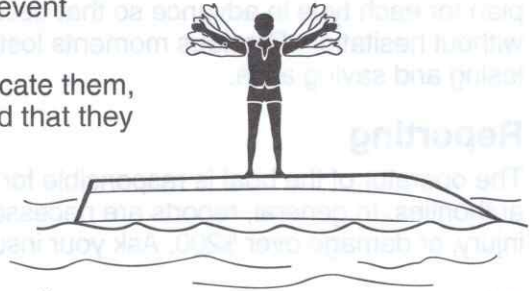

KC-0170

HAZARDOUS CONDITIONS

Every waterway poses hazards that you should avoid; shallow water, tree stumps, sand bars, etc. Ask local boaters for information and consult a marine chart when boating on unfamiliar waters. As the operator of the boat, you should try to avoid all hazards, known and unknown. The following information does not contain all possible water hazards.

Weather

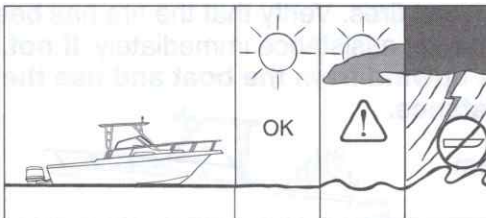

KC-0215

Severe weather can be one of the most dangerous forces boaters encounter. High winds, rough seas and thundersorms may suddenly turn an enjoyable outing into a fear of losing your life. Before starting out on your boat, you must listen to the current forecast, and plan a way to receive warnings and weather advisories while underway.

Every six hours the National Weather Service issues marine forecasts for coastal areas of the U.S., for offshore water and the high seas. Each forecast covers a different coastal area. It contains a summary of the weather patterns in and around the area, plus a prediction of winds, seas, weather and visibility.

BOATING SAFETY



Meteorologists affiliated with radio and TV stations, also offer good marine forecasts for popular boating areas. Tune into one of these sources of weather information to get the current weather picture before setting out.







Countless lives have been saved by advance warnings of approaching severe weather. Marine weather warnings are unique because of the special relationship between wind and waves. The longer the wind blows in a steady direction and the greater the distance over the water, the higher and more powerful the waves. Wind stress on the water builds the wave. Wind of 35 knots may create a 6-foot wave in just two hours; those are considered "severe conditions" for most marine activities. The wind/wave relationship is evident in the range of marine weather warnings.

Weather Information

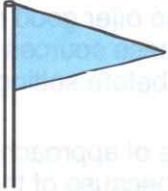
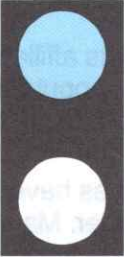
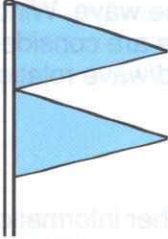
While on the water, the best way to receive timely weather information is by radio. NOAA Weather Radio (NWR), operated by the National Weather Service, provides continuous weather programming for all U.S. waters. For weather broadcasts and their frequencies, see chart to the right.

WEATHER RADIO BROADCAST FREQUENCIES

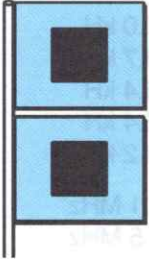
BROADCASTER	FREQUENCIES
NOAA Weather Radio (Range approx. 40 miles)	162.550 MHz (WX-1)
	162.400 MHz (WX-2)
	162.475 MHz (WX-3)
Coast Guard Marine Information Stations	2670.0 kHz
	4428.7 kHz
	6506.4 kHz
	8765.4 kHz
	13113.2 kHz
VHF (Channel 22A) National Bureau of Standards Time and Frequency Service	157.1 MHz
	5 MHz
	10 MHz
	15 MHz

DAYTIME WARNING	DESCRIPTION	NIGHTTIME WARNING
	<p>Small Craft Advisory - Winds greater than 18 knots, sustained for two hours or more or hazardous wave conditions. Following a storm, hazardous wave conditions can persist long after the high winds have subsided.</p>	
	<p>Gale Warning - Sustained winds (2 or more hours), of 34-47 knots.</p>	
	<p>Storm Warning - Sustained winds of 48 knots or greater.</p>	
	<p>Hurricane Warning - Forecast winds of 64 knots and above. Displayed only in connection with a hurricane.</p>	

 Actual Signal in red

KC-0371

BOATING SAFETY



Storms

Take common sense precautions if you are forced to operate your boat in stormy conditions:

- Wear PFDs
- Stow gear below and lash equipment on deck.
- Reduce speed and head for place of refuge you can reach most easily.
- If you lose power, keep boat headed into the waves by rigging a sea anchor off the bow.

Fog

It is best to avoid operating your boat in foggy weather. When fog sets in take bearings and log courses and speeds. You are required to emit a five second blast from your horn or whistle once every minute. Additionally, have passengers wear PFDs and observe for oncoming vessels.

Dam Spillways

The water around a dam spillway is a hazardous area. It is subject to rapid changes. Boaters must keep clear of the spillway areas below dams.

Weeds

Weeds are generally a threat to your boat's engine. Weeds on the propeller may cause the engine to vibrate. They may also restrict water intake causing the engine to overheat. If you run into weeds, stop the engine and clear the propeller and water intake completely of weeds. Consult the engine operating manual for more information.

Note

Weeds can sometimes be removed by shifting to neutral, pausing a moment, then shifting to reverse to unwind the weeds from the propeller.

Shallow Water Operation

Operating in shallow water presents a number of hazards. Water of any depth may contain stump fields, sand bars, rocks, or other unmarked underwater hazards.

If the engine strikes an underwater hazard, check for boat and engine damage. If the engine vibrates excessively after striking an underwater obstruction, it may indicate a damaged propeller.

In coastal areas, tides can effect water level as much as 30 feet. Check with local marinas or Coast Guard stations for tide tables and current charts.

Sand Bars

Sand bars in narrow inlets are constantly shifting, making it difficult to mark them with buoys. Sometimes, sand bars are indicated by waves as they form into breakers when passing over the sand bar. If you ground the boat on a sand bar, seek help from another boater.

Warning Markers

It is a good idea to ask local authorities if there are hazardous areas and how they are marked. Boaters must also recognize the flag designs which indicate that skin divers are present and keep well clear of the area.



Watch for swimmers. Swimming areas may not be marked. Steer clear from the area and always remain alert.



Distress flags indicate a fellow boater is in need of assistance.

Navigation markers serve as a means of identifying navigable routes, and indicate water hazards. Boaters should become familiar with navigation markers and stay within marked boundaries and clear of hazards.

OPERATION BY MINORS

Minors must always be supervised by an adult whenever operating a boat. Many states have laws regarding the minimum age and licensing requirements of minors. Be sure to contact the state boating authorities for information.

PASSENGER SAFETY

Whenever you are going for an outing, make sure that at least one passenger is familiar with the operation and safety aspects of the boat in case of emergency. Show all passengers the location of emergency equipment and show how to use it. Don't allow passengers to drag their feet or hands in the water, or sit on the bow, sundeck, or gunwale while the boat is moving.



WATER SPORTS

Fishing

When fishing it is important to remember that control of the boat comes first and fishing second. Below is a list to guide you concerning safety while fishing:

- NEVER LEAVE THE HELM UNATTENDED WHEN BOAT IS UNDERWAY!
- Observe right-of-way when feasible and keep clear of congested waterways. Other fishermen's lines can become wrapped around your propeller shaft and damage the engine.
- Stow any fishing gear you are not using to prevent breakage or tripping.
- Never anchor in a channel or tie up to a navigational aid. Both are illegal.

Water Skiing

Just as you are responsible for passengers, you are also responsible for the safety and conduct of a water skier. Know the skier's level of experience before you start, and avoid any maneuvers that may cause problems. Courtesy for others is essential in water skiing. When skiing make sure your wake is not causing problems for fishermen and other boatmen.



WARNING



- **Skiers must wear a USCG approved flotation device. A type III water ski vest is an approved and practical PFD.**
- **Keep at least 100' away from all other objects.**
- **When skiing have an experienced driver and aft facing observer in the boat.**
- **Never ski in shallow water or at night.**
- **Never jump from a moving boat.**
- **Always keep a downed skier in sight.**
- **Turn the motor OFF before you get close to someone in the water.**



KC-0270

Diving Operations

The Navigational Rules require vessels which are engaged in diving operations or activity to exhibit a rigid replica of the international Alpha flag not less than one meter in height.

This requirement does not have any impact on the use of the red and white diver's flag which may be used by choice, or required by State or local law to mark the diver's location under water. The Alpha flag is a navigational signal advertising only the vessel's restricted maneuverability. It does not pertain to the diver.

DIVERS FLAG



RED

BLUE

USED BY RECREATIONAL DIVERS - INDICATES DIVER'S POSITION

ALPHA FLAG

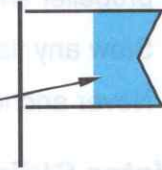

WORLDWIDE VESSELS ENGAGED IN DIVING OPERATIONS - DOES NOT INDICATE DIVER'S POSITION

KC-0372

Marine Radio

The VHF Marine Radio is a vital communication link for offshore boating. Misuse of it seriously affects the safety of all boaters. It is important for your safety to use the proper channel for each type of message. The channel listing section can aid you in selecting marine channels. The use of unauthorized channels can cause harmful interference. Consult FCC Rule Part 80 for a complete channel listing and restrictions on use.

BOATING SAFETY



VHF CHANNEL LISTINGS

	CHANNEL	EMERGENCY PROCEDURES
DISTRESS SAFETY CALLING	16	EMERGENCY PROCEDURES MAYDAY: IMMEDIATE DANGER TO LIFE AND/OR PROPERTY. SEQUENCE: 1. Select Channel 16. 2. Repeat MAYDAY three times. 3. Give vessel name and call sign. 4. Give position. 5. Describe emergency. 6. If no answer, repeat, then try another channel.
Ship-to-Ship (Safety Only)	6	
Digital Selective Calling (DSC)	70	
Working Channels for Recreational Vessels		
-Ship-to-ship or ship-to-shore	9, 68, 69, 71, 78	
-Ship-to-ship only	72	
Marine Operator	24 to 28, 84 to 87	
-For Great Lakes	88	
St. Lawrence Seaway, Puget Sound and Strait of Juan de Fuca and its approaches only		
Navigation		
-Bridge to Bridge	13*	
-Lower Mississippi River and adjacent waters only	67*	
*REDUCE POWER TO 1 WATT ON CHANNELS 13 & 67		

MONITOR CHANNEL 16

GENERAL PRECAUTIONS

Your safety, the safety of your passengers, and other boaters are among your responsibilities as operator of this boat. Your boat must be in compliance with U.S. Coast Guard safety equipment regulations. You should know how to react correctly to adverse weather conditions, have good navigation skills, and follow the "rules of the road" as defined by the Coast Guard and state/county/local regulations.

You must never operate a boat while under the influence of alcohol or any other drug. Remember...you are also responsible for the alcohol/drug use and on-board behavior of your passengers. Drugs reduce your reaction time and affect your better judgement. When combined with the sun, wind, noise and activity of boating, drugs compound fatigue and can be very dangerous.

Before each outing you should check all safety equipment, such as fire extinguishers, PFDs, flares, distress flags, flashlights, engine stop switch, etc. They should be operable, in good condition, readily visible, and easily accessed.

Complete a float plan and tell someone of your travel plans. Check local weather reports before casting off; do not leave the dock area when strong winds and electrical storms are in the area or predicted to be in the area.

Know the weight capacity of your boat. Do not overload your boat.



WARNING



Read and understand this manual and the engine manual, and be sure that you understand all controls and operating instructions before attempting to operate the boat. Improper operation can be extremely dangerous.

3. Give correct name and call sign	21. Lubricate the engine
4. Give position	22. Fuel system
5. Describe emergency	23. Start & handle fuel stop
6. If no answer, repeat, then try another channel	24. Stoppage with
	25. Stoppage with
	26. Stoppage with
	27. Stoppage with
	28. Stoppage with
	29. Stoppage with
	30. Stoppage with

GENERAL INFORMATION

Your safety, the safety of your passengers, and other boats are among your responsibilities as operator of this boat. Your boat must be in compliance with U.S. Coast Guard safety equipment regulations. You should know how to react correctly to adverse weather conditions, have good navigation skills, and follow the "rules of the road" as defined by the Coast Guard and state/country/local regulations.

You must never operate a boat while under the influence of alcohol or any other drug. Remember... you are also responsible for the alcohol/drug use and on-board behavior of your passengers. Drugs reduce your reaction time and affect your best judgment. When combined with the sun, wind, noise and activity of boating, drug compound fatigue and can be very dangerous.

Before each outing you should check all safety equipment, such as the extinguishers, PFDs, ladders, distress flags, flashlight, engine stop switch, etc. They should be operable in good condition, readily visible, and easily accessed.

2

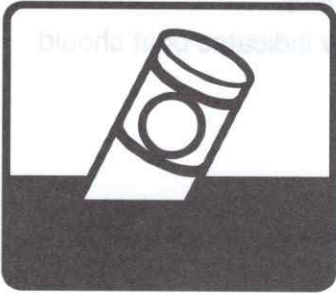

BASIC RULES OF THE ROAD



CAUTION

The nautical rules of the road must be followed to prevent collisions between vessels. Like traffic laws for automobiles, the operator is legally required to follow the rules.

The following information outlines only the most basic of the nautical rules of the road. For more information, contact your local U.S. Coast Guard Auxiliary.

AIDS TO NAVIGATION

Learn to recognize the different buoys and day markers; they are the signposts of the waterway. There are 2 primary marking systems in use in the U.S.; the Uniform State Waterway Marking System (USWMS) used on inland waters and maintained by each state, and the Federal Waterways Marking System (FWMS) used on coastal waters and rivers and maintained by the U.S. Coast Guard (USCG). In addition, the FWMS has two modified systems; Western River Buoyage, and Intracoastal Waterway Buoyage. Be sure to check with local authorities on the buoyage system in use.

The type of hazard/warning buoys and markers depend on the area of jurisdiction. Check with local boating authorities.

USWMS System

In the USWMS Lateral System, well defined channels are marked with red and black buoys. Lateral means the sides of the channel are marked and the boat should pass between them.

The USWMS Cardinal System is used when there is no well defined channel or where an obstruction may be approached from more than one direction. With the cardinal system:

- Pass north or east of BLACK-TOPPED WHITE buoy.
- Pass south or west of RED-TOPPED WHITE buoy.
- RED and WHITE VERTICALLY STRIPED buoy indicates boat should pass outside of the buoy (away from shore).

Uniform State Regulatory Markers

USWMS regulatory markers are white with international orange geometric shapes; you must obey regulatory markers.

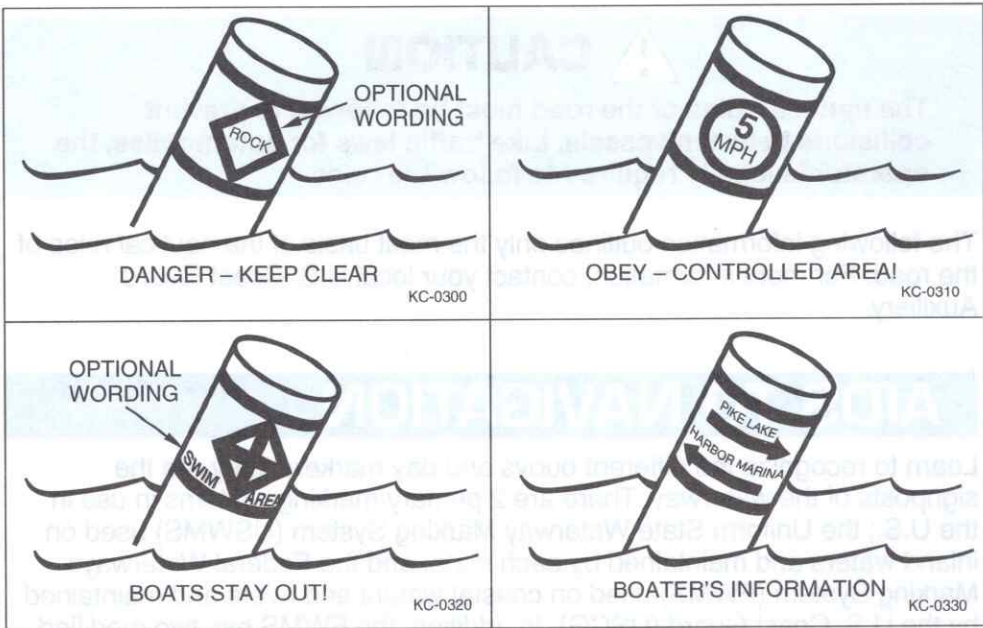

BASIC RULES OF THE ROAD



FWMS System

The FWMS Lateral System is for use on navigable waters except Western Rivers and Intracoastal Waterways.

The markings on these buoys are oriented from the perspective of being entered from seaward (the boater is going towards the port). This means that red buoys are passed on the starboard (right) side when proceeding from open water into port, and black buoys are to port (left) side.

The right side (starboard) of the channel is marked with RED, even numbered buoys. The left (port) side of the channel is marked with GREEN, odd numbered buoys.



UNLIGHTED
BELL BUOY



SPAR BUOY



CAN BUOY



LIGHTED BUOY



NUN BUOY

KC-0420

The middle of the channel is marked with RED and WHITE vertically striped buoys; pass close to these buoys.



SPHERICAL SAFE
WATER MARKER

KC-0430

Obstructions, channel junctions, etc. are marked with RED and GREEN horizontally striped buoys.

A RED band at the top means the preferred channel is to the left of the buoy; a GREEN top band means the preferred channel is to the right of the buoy.

STARBOARD
DAY
MARKER



Day markers are colored and numbered the same as buoys. RED, triangular day markers with even numbers mark the starboard side of the channel. GREEN, square day markers with odd numbers mark the port side of the channel.

PORT
DAY
MARKER



KC-0440

Lights, bells and horns are used on buoys for night or poor visibility conditions.

RIGHT-OF-WAY



CAUTION

In general, boats with less maneuverability have right-of-way over more agile craft. Likewise smaller boats should give way also. You must stay clear of the vessel with right-of-way and pass to his stern.

Privileged Boats

Privileged boats have right-of-way and can hold course and speed. Sailboats and boats paddled or rowed have the right-of-way over motor boats. Sailboats under power are considered motorboats. Small pleasure craft must yield to large commercial boats in narrow channels.

Burdened Boats

The burdened boat is the boat that must make whatever adjustments to course and speed necessary to keep out of the way of the privileged boat.

Crossing Situation

In crossing situations, the boat to the right from the 12 o'clock to the 4 o'clock position has the right-of-way. It must hold course and speed. The burdened boat keeps clear and passes behind the privileged boat. Boats going up and down a river have the privilege over boats crossing the river.

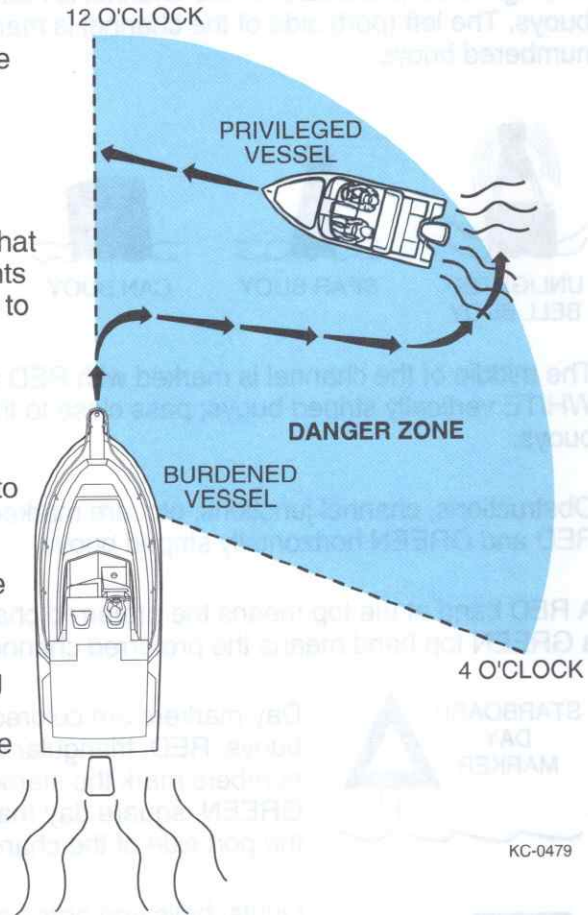

KC-0479

BASIC RULES OF THE ROAD



Meeting Head-On

Neither boat has the right-of-way in this situation. Both boats should decrease speed, should turn to the right, and pass port-to-port. However, if both boats are on the left side of a channel, each vessel should sound two short horn blasts and pass starboard to starboard.

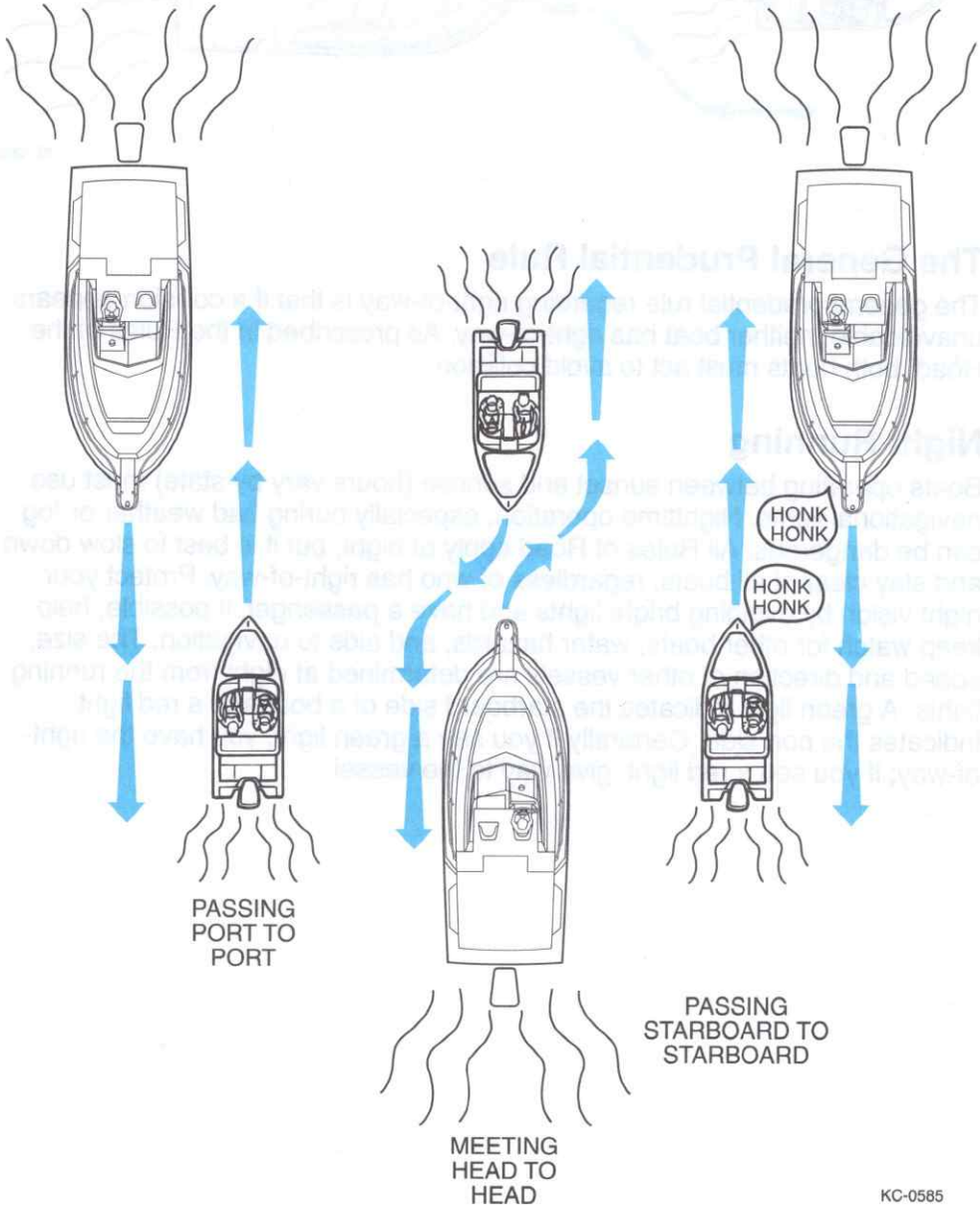

KC-0585

Overtaking

The boat that is overtaking one ahead of it is the burdened boat and must make any adjustments necessary to keep out of the way of the privileged boat.

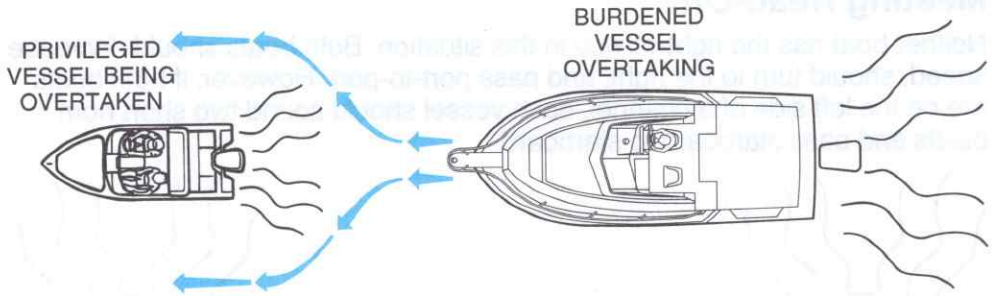

KC-0605

The General Prudential Rule

The general prudential rule regarding right-of-way is that if a collision appears unavoidable, neither boat has right-of-way. As prescribed in the Rules of the Road, both boats must act to avoid collision.

Night Running

Boats operating between sunset and sunrise (hours vary by state) must use navigational lights. Nighttime operation, especially during bad weather or fog can be dangerous. All Rules of Road apply at night, but it is best to slow down and stay clear of all boats, regardless of who has right-of-way. Protect your night vision by avoiding bright lights and have a passenger, if possible, help keep watch for other boats, water hazards, and aids to navigation. The size, speed and direction of other vessels are determined at night from the running lights. A green light indicates the starboard side of a boat and a red light indicates the port side. Generally if you see a green light, you have the right-of-way; if you see a red light, give way to the vessel.

3

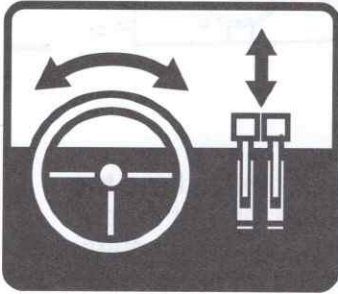

CONTROLS AND INDICATORS

Knowing the controls and indicators on your boat is essential for safe and proper operation. The controls and indicators shown in this section may be optional or slightly different than those on your boat.

SHIFT/THROTTLE CONTROL

The shift/throttle control on your boat differs from model to model and may depend on the engine used. The following control is typical of the operation of most remote controls. Be sure to consult the engine or control manual for operational differences.

CAUTION

Do not shift too quickly from forward to reverse. Stay in neutral, or idle position until the boat has lost most of its headway before completing the shift to reverse or engine damage may occur.

This one-hand, single lever control operates as both a gear shifter and a throttle. The lever automatically locks in the neutral (straight up and down) position for safety when starting. The lever can only be moved from neutral by pressing the neutral lock release button. Shifting is accomplished by moving the lever into the first 15° of travel; push the lever for forward, and pull the lever back for reverse. By advancing the lever beyond 15°, you move from the shifting range to the throttle range.

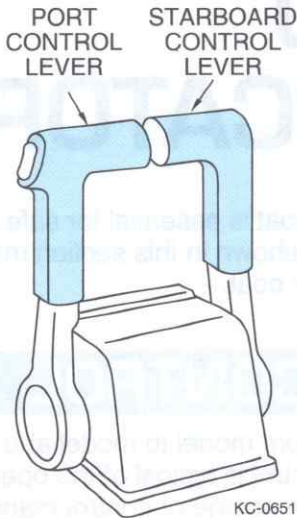
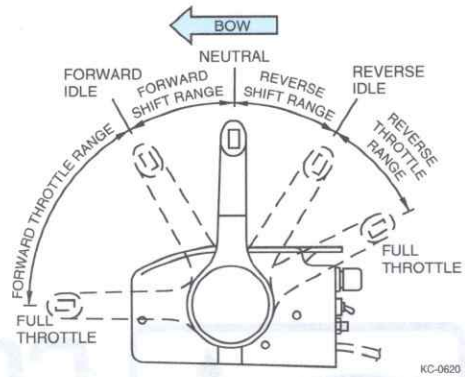

Twin engine models have two control levers; one for the port engine, and one for the starboard. Single lever controls for twin engines operate nearly the same as a single engine. Be sure to consult the control operator's manual.

INSTRUMENTS

Instruments are illuminated for night operation. Their type, number, and location vary by model; some may not appear on your model. Twin engine models have port engine gauges on the left and starboard engine gauges on the right of the console.

Tachometer

Registers engine speed in revolutions per minute. Use this gauge to keep the engine within the proper operating range. Consult the engine manual for the proper RPM operating range for your engine.

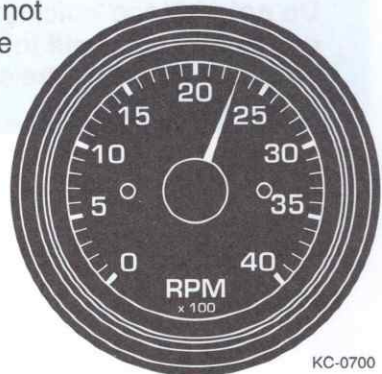

CONTROLS AND INDICATORS

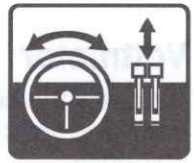

Speedometer

Registers forward boat speed in miles per hour. Use this gauge to monitor fuel consumption and propeller performance. Since most marine speedometers operate with water pressure, accuracy is only approximate.

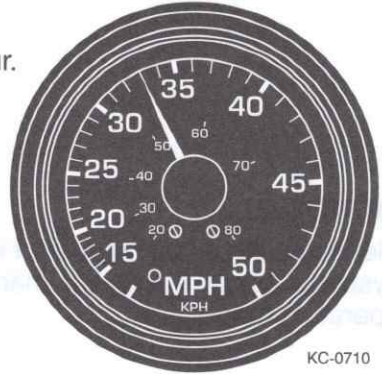

KC-0710

Fuel Gauge

On models with a permanent fuel tank, this gauge registers approximate fuel level in the gas tank. The ignition switch must be in the RUN position to activate the gauge.

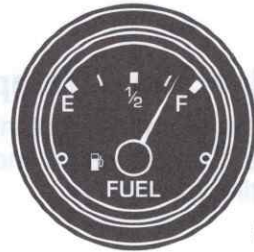

KC-0720

Water Pressure Gauge

Registers the water circulated by the water pump in pounds per square inch (PSI). Use this gauge to observe that the engine cooling system is operating properly. Consult the engine manual for the normal operating PSI range.



KC-0730

Trim Gauge

Measures engine or stern drive tilt and indicates the relative position of the bow, up or down when boat is on plane. Use this gauge to monitor boat trim.



KC-0740

Voltmeter

Indicates the condition of the main or cranking battery in volts DC. Normal operating range is 12+ volts.

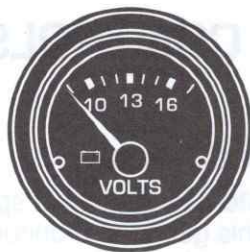

KC-0750

Ammeter

Measures the charging current in the electrical system. Consult the engine manual for the normal operating range.



KC-0760

Engine Water Temperature Gauge

Indicates the water/coolant temperature inside the engine. Consult the engine manual for the normal operating range.



KC-0770

Engine Oil Pressure Gauge (Stern Drive Only)

Indicates the pressure of the lubricating oil inside the engine. Consult the engine manual for the normal operating range.



KC-0780

Engine Hourmeter

Registers accumulated engine operating time, and is activated when the ignition switch is in the "ON" position. Be aware that time will be logged whenever the ignition switch is "ON", even when the engine is not running. Use the hourmeter to keep accurate logs for scheduled maintenance.

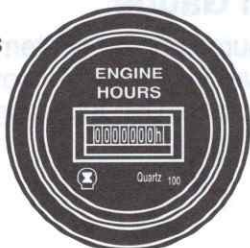

KC-0782

CONTROLS AND INDICATORS

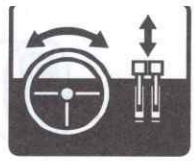

Switches

Each electrical circuit on your boat is equipped with a control switch. Some switches may have an LED indicator for easy ON/OFF identification. Most switches will have a fuse holder, or circuit breaker adjacent to the switch.

Master Power Switch – Disconnects the boat electrical systems from the batteries. When not using the boat, keep this switch in the OFF position.

Fuel Gauge Switch – Allows you to check the amount of fuel in the fuel tank when the navigation lights are OFF or the ignition switch is OFF.

Navigation Lights Switch – Controls the running and anchor lights for night operation. NAV position will turn on the red and green bow lights, white stern light, and gauge illumination. ANC position turns on only the white stern light for night anchoring.



CAUTION

Never operate the boat between sunset and sunrise with the switch in the anchor light position. Running lights are required to indicate direction and right-of-way at night.

Blower Switch (Stern Drive Only) – Activates the engine box ventilation blower to remove explosive fumes from the box and bilge areas.

Bilge Switch – Activates the bilge pump to remove excess water from the bilge. Some models are equipped with an automatic bilge pump setting. Switch to AUTO whenever the boat is in operation, water will be pumped-out as it enters the bilge.

CAUTION

Be sure to switch the bilge OFF when the boat is not in use. Wave action or trailer travel can cause the pump to run down the battery.

Ignition Switch – Starts and stops the engine. Be sure to consult the engine operator's manual for information.

Horn Button – Push and hold to sound the horn.

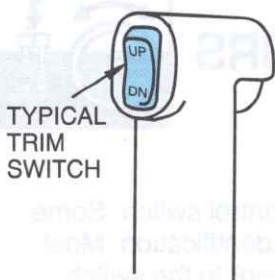

KC-0931

Trim Switch – If your engine is equipped with power trim and tilt, this switch activates that function. Push and hold the switch until the engine is at the desired angle. Use this switch in combination with the trim gauge.

Engine Stop Switch and Lanyard –

The engine stop switch stops the engine when engaged. Attach the lanyard to the boat operator whenever the engine is running. If the operator is thrown from the seat or moves too far from the helm the lanyard will engage the switch and shut off the engine.

To attach the lanyard, hold out the button head and slide the fork beneath the safety switch. Attach the hook on the opposite end of the lanyard to a strong piece of clothing on the operator, such as a belt loop.

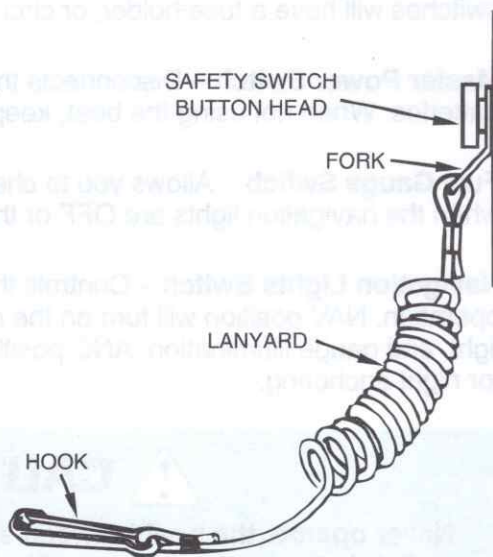

KC-0950

! WARNING !

Attach the Engine Stop Switch lanyard to the operator before starting the engine. This will prevent the boat from becoming a runaway if you are accidentally thrown from the boat.

The Engine Stop Switch can only be effective when it is in good working condition. Observe the following:

- **Never remove or modify the Engine Stop Switch and/or lanyard.**
- **Lanyard must always be free from obstructions that could interfere with its operation .**

ONCE A MONTH: Check switch for proper operation. With engine running, pull lanyard. If engine does not stop, see your DEALER for replacement of switch.

CONTROLS AND INDICATORS



Trim Tab Switch – Controls the position of a trim tab. Pressing the top of the rocker switch will raise the trim tab. Pressing the bottom of the rocker switch will lower the trim tab.

Water Pump (Fresh Water) – Activates the pressurized fresh water system.

Water Pump (Raw Water) – Activates the raw water pump.

Battery Selection Switch – Permits current to be carried by either of the two batteries, by two batteries simultaneously, or cuts off current at the source.



CAUTION

Never turn the battery select switch to “OFF” with the engine running as this could damage the charging system.

More than two batteries may be used. Contact your boat dealers electrical technician for other concepts and designs.

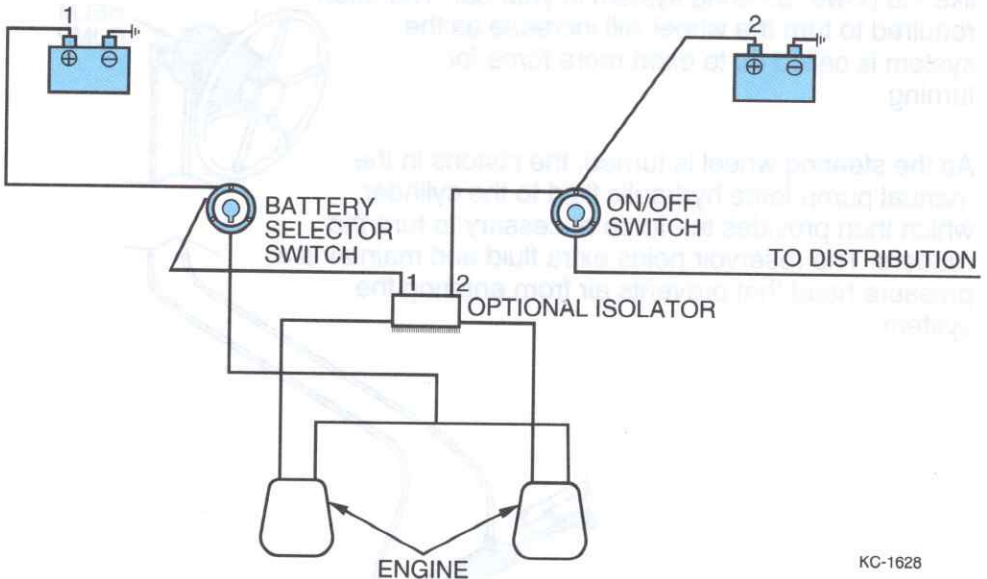

KC-1628

One battery selector switch, one on/off or selector switch, two alternators, one isolator, two batteries – In the example, the isolator separates both alternators so both batteries will charge simultaneously, automatically charges lowest battery first. Both batteries can be used for start or accessory source.

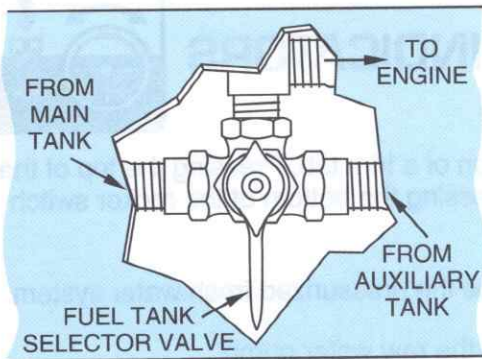

KC-1001

Fuel Tank Selector Valve – On models equipped with both a main and auxiliary fuel tank, this valve is used to select fuel from either tank. Most valves are located in the helm area; rotate the valve lever to draw fuel from the desired tank.

Compass – Aids with navigation by indicating where NORTH is located. The compass must be adjusted for the area you are in. Refer to supplemental information for instructions.



KC-0920

HYDRAULIC STEERING SYSTEM

The manual hydraulic steering system does not act like the power steering system in your car. The effort required to turn the wheel will increase as the system is called on to exert more force for turning.

As the steering wheel is turned, the pistons in the manual pump force hydraulic fluid to the cylinder, which then provides the force necessary to turn the rudders. The reservoir holds extra fluid and maintains a pressure head that prevents air from entering the system.

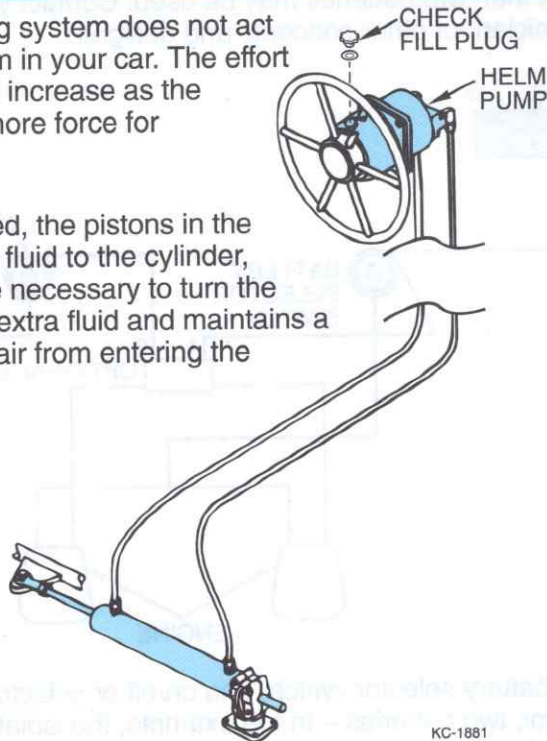

KC-1881

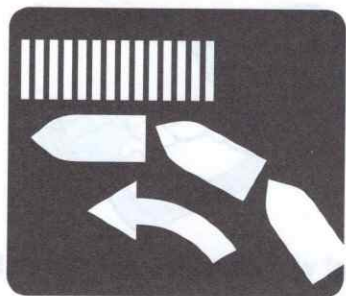

4

OPERATION

This section describes the basics of fueling, starting, running, trimming, docking and starting your boat. Since there is a variety of control and engine options, be sure to consult the other owner's manuals provided with your boat.

FUELING

There are two types of fuel systems: portable and built-in. Portable tanks must be removed from the boat when fueling. Consult the engine operator's manual for proper procedures. Built-in tanks have the fuel filler aft in the boat. Some models with oil injection also have fillers for the oil reservoir.



WARNING



Gasoline is extremely flammable and highly explosive under certain conditions. Always stop the engine and never smoke or allow open flames or sparks within 50 feet of the fueling area when refueling.

Take care not to spill gasoline. If gasoline is spilled accidentally, wipe up all traces of it with dry rags and immediately dispose of the rags properly onshore. When fueling:

- Close all doors, hatches, windows, and other compartments.
- Extinguish cigarettes, pipes, stoves, and all other flame producing items.
- Make sure all power is off, and do not operate any electrical switches.
- Remove fuel fill cap. Insert hose nozzle and make sure nozzle is in contact with or grounded against fill opening. This will reduce the risk of static spark.
- Observe fuel flow constantly to prevent overflow or spillage.
- Add fuel. Do not fill to capacity to allow for fuel expansion.
- Tighten the fuel filler cap completely after refueling.
- Check oil level.

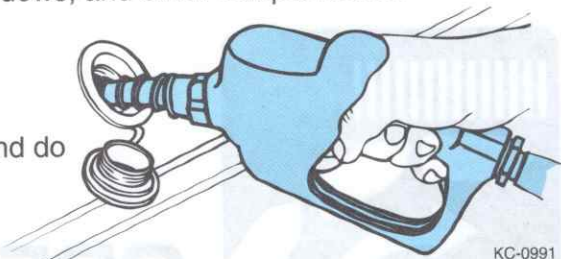

Note

Each time you fill up, inspect fuel lines for leaks and hose deterioration.

After fueling, you should:

- Close fill cap securely and wipe up spillage.
- Open all windows, hatches, doors, and compartments.
- In stern drive boats, turn the bilge blower on and run at least 4 minutes before starting engines. Check for gas fumes in the engine compartment before starting and continue to run the blower until they are eliminated.

LUBRICATION (Outboards)

Your engine may be equipped with an oil injection system that automatically feeds oil to the engine. Use lubricant that is recommended by the manufacturer, or NMMA TC-WII certified. You will find the recommended lubricant listed in the engine manual. If you need assistance, consult your dealer.



STARTING

1. Squeeze fuel primer bulb several times until firm (outboard models).



WARNING



The blower must be operated for a minimum of four minutes before each time the engine is started. In addition, the blower should be operated continuously when at idle or slow speed running. Failure to operate the blower can cause an explosion.

2. Attach Emergency Engine Stop Switch lanyard to its switch and to the operator.
3. Place shift/throttle control handle in NEUTRAL.
4. Turn key clockwise to START position. After motor starts, release key.



CAUTION

Always go slowly in reverse to avoid taking water in over the transom. You can swamp the boat by taking on too much water.

SHIFTING/RUNNING

Follow these guidelines when shifting your boat:

- Pause in neutral before shifting from forward to reverse, or reverse to forward.
- Avoid shifting into reverse while the boat is traveling forward at speed.
- Keep the shifter control clean and clear of obstructions.

To shift into forward: press the neutral lock button while pushing the control lever forward.

To shift into reverse: press the neutral lock button while pushing the control lever backward.

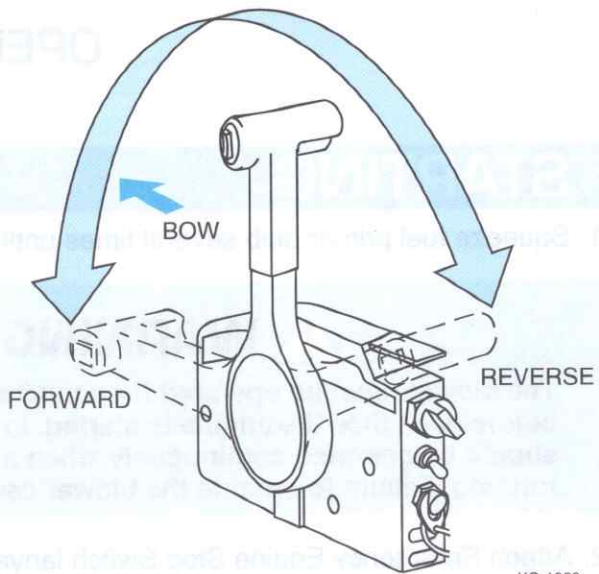

WARNING ALARM

CAUTION

Continued operation after the warning alarm has sounded may cause severe engine damage.

Your boat may be equipped with a warning alarm that will sound if an engine problem develops. If the warning alarm sounds, **IMMEDIATELY** throttle back to idle speed and shift into neutral. **IMMEDIATELY** check the gauges and stop the engine. On some models, the horn may emit a short chirping sound during starting to verify operation.

STEERING CONTROLS

Practice steering your boat. Make sure that the steering system is working correctly and is properly maintained. Follow these guidelines to keep your boat handling well.

OPERATION

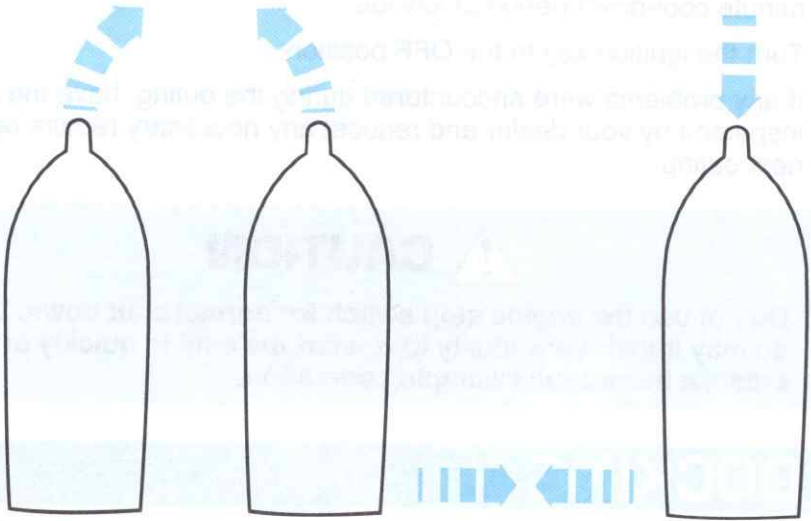
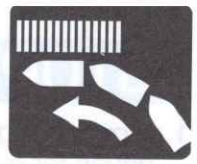

RIGHT TURN

Turn wheel to right—Stern will move to left.

LEFT TURN

Turn wheel to left—Stern will move to right.

BACKING TO LEFT

Turn wheel to left—Stern will pull to left.

KC-1075

- Keep the cable end clear of obstructions such as wiring, control cables, fuel lines, tow lines and mooring lines.
- Keep the moving parts clean and lubricated.
- Inspect the steering cables for kinks, damage, and corrosion.



WARNING



The steering system must be in good operating condition for safe boat operation. Frequent inspection, lubrication, and adjustment by your dealer is recommended.

All boats have a tendency to wander somewhat at slow speeds. A natural reaction to this effect is to steer the boat back and forth in an attempt to compensate for wandering. Invariably, the compensation will result in oversteer and only worsen the effect. Keep the steering wheel in the center position, the boat will wander back and forth somewhat, but the overall course will be a straight one.

STOPPING

1. Slowly bring the control lever to the idle position. If the boat has been driven for a long period of time at high speed, allow the engine a 2-3 minute cool-down period at low idle.
2. Turn the ignition key to the OFF position.
3. If any problems were encountered during the outing, have the boat inspected by your dealer and request any necessary repairs before the next outing.



CAUTION

Do not use the engine stop switch for normal shut down. Doing so may impair your ability to re-start the engine quickly or may create a hazardous swamping condition.

DOCKING

Practice docking before attempting it for the first time. Use a float, like a plastic milk jug with a line and small weight, as your docking target.



WARNING



Never use your hand, arm or other part of your body to attempt to keep the boat from hitting the dock. The boat could push against the dock, causing an injury.

Follow these guidelines when docking:

- Approach docks with the port side of the boat if possible.
- Come to a stop a short distance from the dock, then proceed slowly.
- Have fenders, mooring lines and crew ready.
- Observe how the wind and current are moving your boat. Approach the dock with the boat pointed into the wind, if possible. If the wind or current is pushing you away from the dock, use a sharper angle of approach. If you must approach the dock downwind or down current, use a slow speed and shallow angle. Be ready to reverse to stop and maintain position.
- If there is no wind or current, approach the dock at a 10 to 20 degree angle.

OPERATION

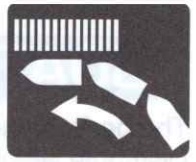

- If possible, throw a line to a person on the dock and have that person secure a bow line.
- With the bow secure, swing the stern in with the engine, or pull it in with a boat hook.

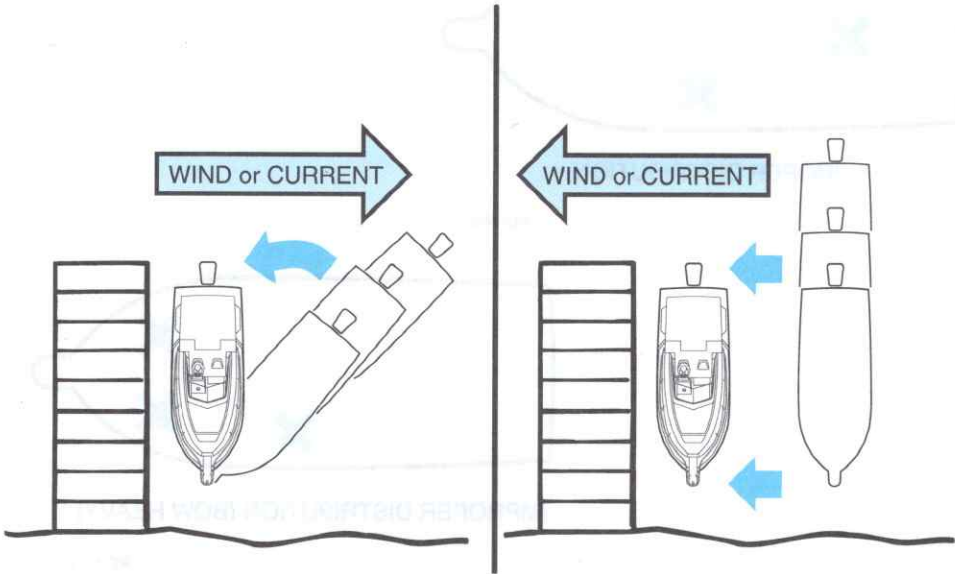

KC-1124

Before tying-up the boat, be sure to use enough fenders to protect the boat from damage. If possible, tie-up with the bow towards the waves with a good quality double-braided nylon line. Tie-up only to the lifting or tie-down eyes; never use the handrails or windshield frames. If the boat is to be moored for a long period of time, use chafing protectors on lines to protect the gelcoat finish. Leave a little slack in the lines to allow for some wave movement or tidal action if applicable.

Follow these guidelines when departing:

- Very slowly shift into forward at idle speed.
- When the stern moves away from the dock, turn the engine away from the dock.
- Cast off bow line and back away.

If the wind or current is pushing away from the dock, cast off all lines and allow to drift until you are clear.

BOAT TRIM

The performance of your boat depends on load weight and distribution. Distribute weight evenly, from bow to stern, and also from port to starboard. After loading, the boat's trim can be adjusted by changing the engine trim angle.

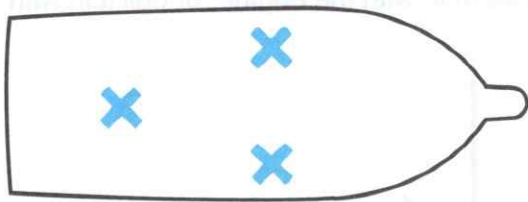

PROPER DISTRIBUTION

KC-1262

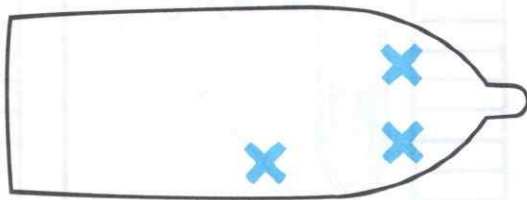

IMPROPER DISTRIBUTION (BOW HEAVY)

KC-1272

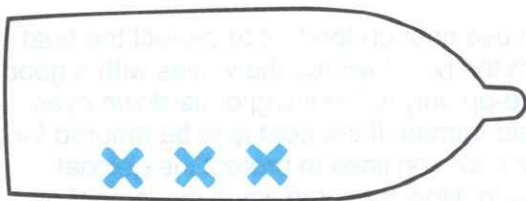

IMPROPER DISTRIBUTION
(STARBOARD HEAVY)

KC-1282

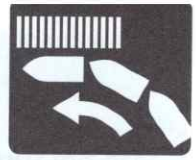

DRIVE TRIM ANGLE

Trim angle is the angular relationship between the lower drive unit and the transom of the boat. Boat trim while underway greatly affects boat performance and efficiency. For best results, the boat should be on plane and trimmed to reduce the wetted surface. With less boat in the water, both speed and fuel economy increases. Engines with manual trim must be adjusted for best overall operation for the load and conditions. Engines with power trim should be adjusted continuously for best results.

If the engine is trimmed in too far (closer to the boat bottom), speed drops, fuel economy decreases, and the boat may not handle correctly. However, it does provide better acceleration from a stand still; and because it forces the bow down, visibility is improved. If the engine is trimmed out too far (away from the boat bottom), steering torque may increase, the boat may be difficult to get on a plane, and may bounce.

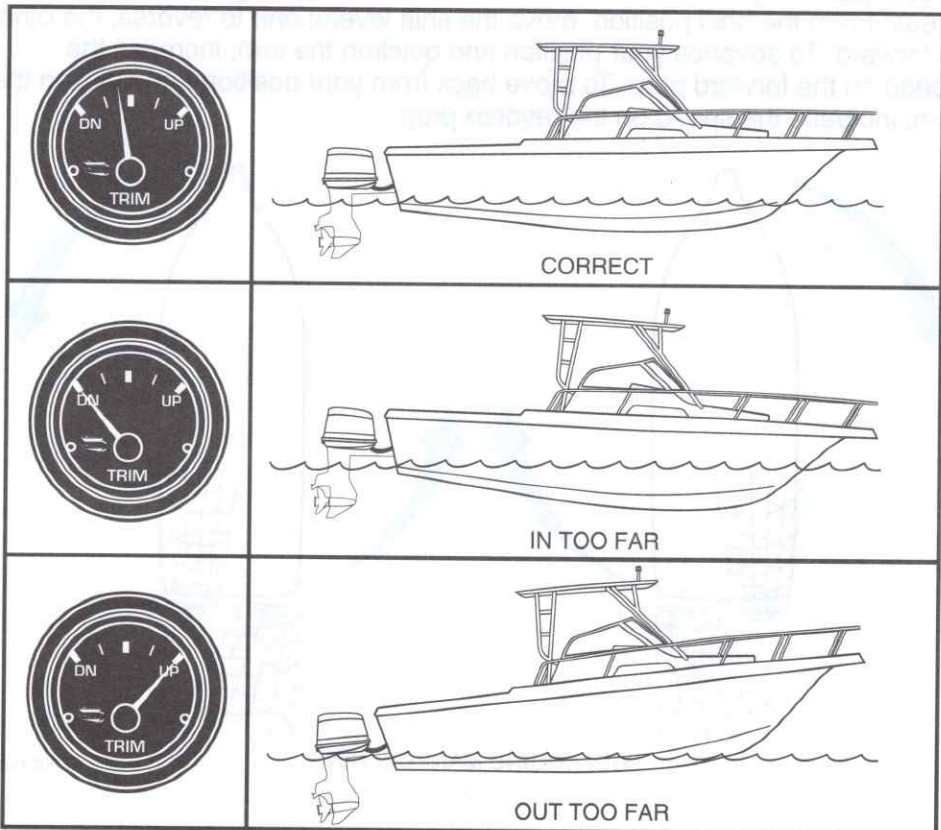

WARNING

Do not trim the engine out too far or the boat may begin to “porpoise” (bounce up and down). Porpoising reduces control and visibility.

To use power trim effectively, always start with the engine trimmed in. As the boat planes, increase the angle out. Experience is the best teacher for understanding proper trim.

SHARP AND CLOSE QUARTERS TURNS (Twin Engine Models)

A sharp turn can be achieved by putting one shift lever in forward position and the other in reverse position. The rate of the turn can be controlled by the engine position as well as engine speed.

Close quarters or “on-a-dime” turns can be used to change direction in small areas. From the hold position, move the shift levers: one to reverse, the other to forward. To advance your position and quicken the turn, increase the speed on the forward prop. To move back from your position and quicken the turn, increase the speed on the reverse prop.

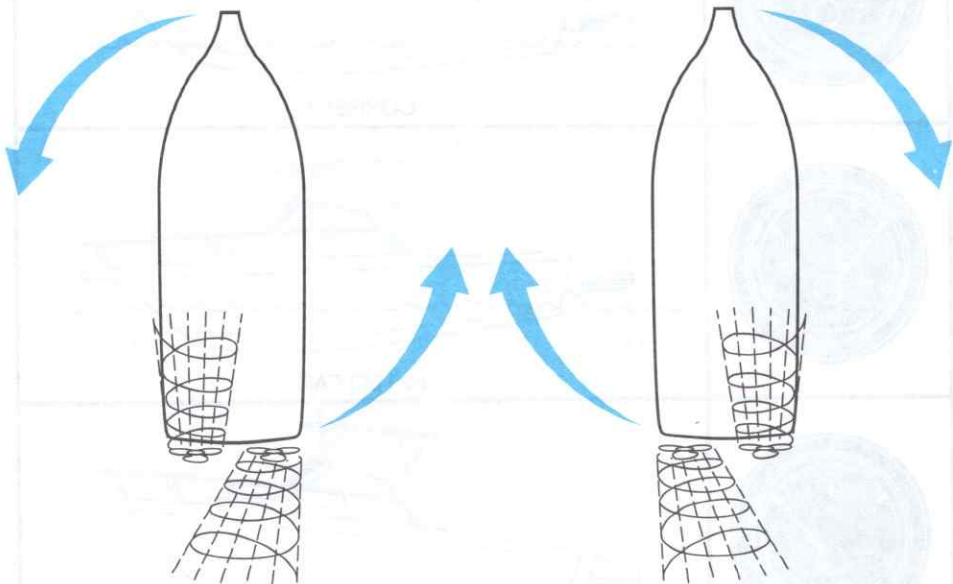

TWIN ENGINE MANEUVERING

KC-1521

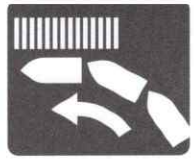

COUNTER-ROTATION (Twin Engine Models)

One propeller turns clockwise while the other turns counterclockwise. They keep you on an even keel and help you hold a true course by eliminating the tendency of your dual-powered boat if equipped, to steer and to veer.

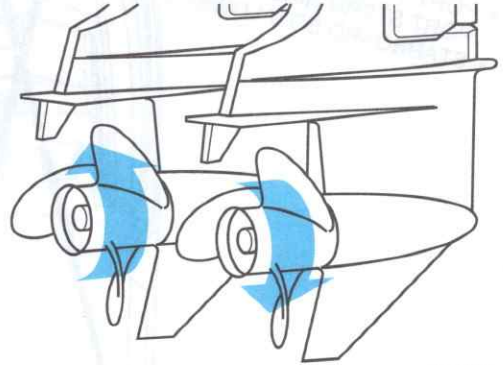

KC-2340

TRIM TABS

Two trim tabs, located at the outside of the transom, even with the boat bottom, help to correct the attitude and control of the boat. Water is deflected and redirected as the trim tabs are raised and lowered. This change in waterflow creates upward pressure under the tabs, and raises the stern. When the stern raises, the bow is lowered. Likewise, lowering the port tab will cause the port stern to raise, making the starboard bow lower.

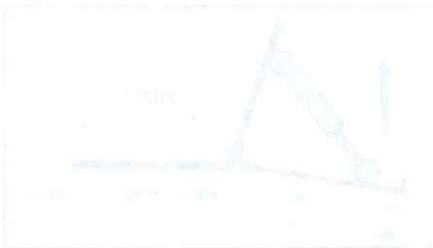

- PORT TAB LOWERS
- PORT STERN RISES
- STARBOARD BOW LOWERS

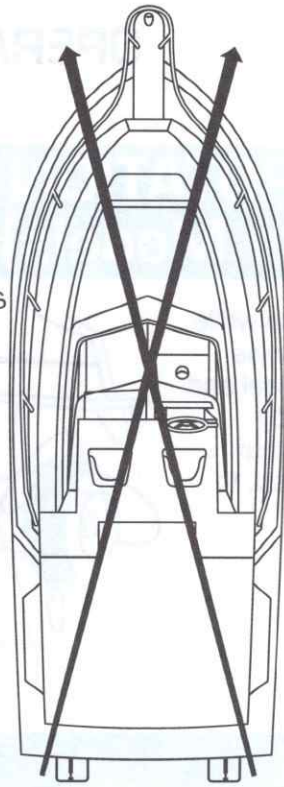

- STARBOARD TAB LOWERS
- STARBOARD STERN RISES
- PORT BOW LOWERS

KC-1158

Using trim tabs in conjunction with the power trim will compensate for uneven weight distribution, listing, water conditions, and other factors that cause inefficient operation. Remember that trim tabs are trimming the hull while power trim is trimming the engine drive.



WATER IS REDIRECTED
CREATING UPWARD
FORCE AT STERN

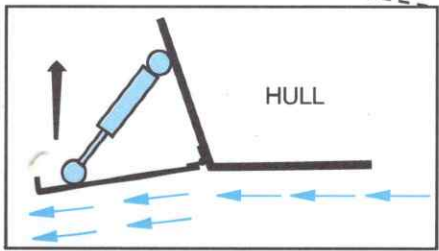

KC-1159

OPERATION

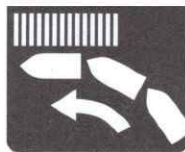

To use the trim tabs with the power trim:

1. Adjust the trim tabs to achieve a planing attitude.
2. Use the power trim to position the prop path parallel to the waterflow.

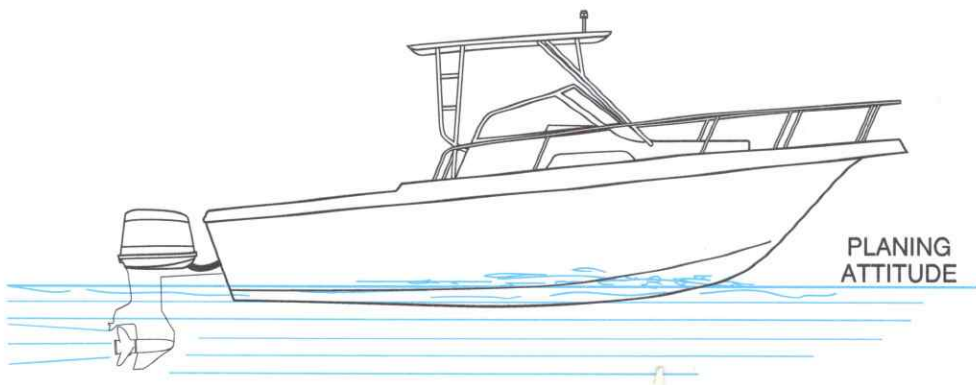
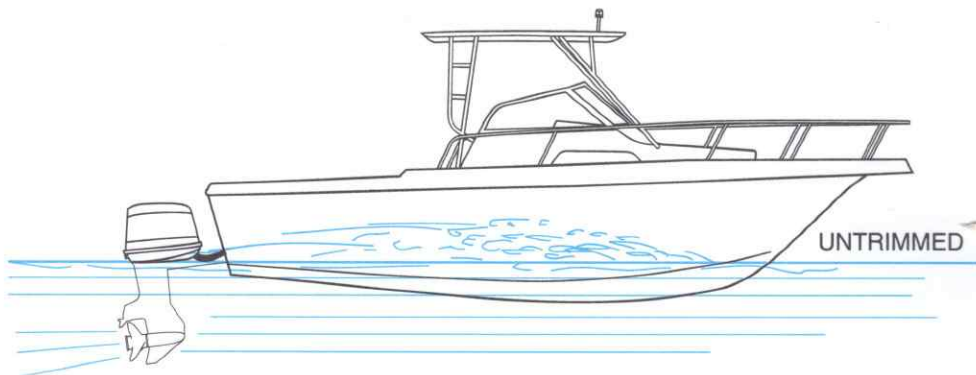

KC-1161

3. Re-adjust the trim tabs to fine tune attitude.
4. Do not overtrim because bow will dig in, causing the boat to veer.
5. To avoid listing, do not move one tab significantly further down than the other while underway.



WARNING



Improper use of trim tabs at high speeds can cause an accident or injury.

5

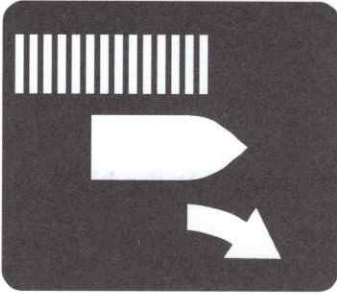

GETTING UNDERWAY

There are many things to consider to make your fishing trip safe and enjoyable. This section includes a safety checklist, boarding guidelines, boat loading, and capacity information.

The contents of this section should be read and understood before casting off. Remember, if you have a problem during your cruise, you can't get out and fix it, or walk to safety or for help.

You are responsible for the safety of all passengers, the boat, and any damage the boat or its wake may cause. Always keep passengers from blocking your view so that you do not run into other boats, swimmers, water skiers, personal water vehicles, or aids to navigation.

SAFETY CHECKLIST

The following checks are essential to safe boating and must be performed before starting the engine. Get in the habit of performing these checks in the same order each time so that it becomes routine.



WARNING



DO NOT launch the boat if any problem is found during the Safety Check. A problem could lead to an accident during the outing causing severe injury or death. Have any problem attended to immediately; see your dealer.

Fuel Management

Use the “one third” rule in fuel management. Use one-third of the fuel to get there, one-third to get back and keep one-third in reserve.

Pre-Operation

- Check the weather report, wind and water conditions.
- Check that the required safety equipment is on board.
- Check that the fire extinguisher is fully charged.
- Check that bilge drain plug is installed properly.
- Check fuel filter for water
- Check that no fuel, oil or water is leaking or has leaked into the bilge compartment.
- Check water separator.
- Check all hoses and connections for leakage and damage.
- Check the propeller for damage.
- Check the engine cooling water intake pick-up for blockage.
- Check that battery terminals are clean and tight.
- Check electrical circuits (lights, pumps, horn, etc.) for proper operation.
- Check that throttle/shift control is in neutral.
- Check that the steering system operates properly.
- Check that all required maintenance has been performed.

During Operation

- Check gauges frequently for signs of abnormal behavior.
- Check that controls operate smoothly.
- Check for excessive vibration.

After Operation

- Fill fuel tank to prevent moisture due to condensation.
- Check for fuel, oil and water leakage.
- Check the propeller for damage.

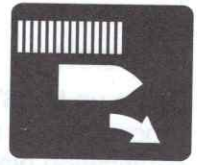

SAFETY EQUIPMENT

Federal and local laws require certain safety equipment to be on board at all times. In addition, responsible boaters carry other equipment in case of emergency. Check with local boating authorities for any additional requirements over and above federal requirements.

BOARDING

When boarding the boat, always step in. Do not jump. Avoid stepping on fiberglass or other potentially slippery surfaces. Board one person at a time.

Do not board the boat while carrying gear. Set gear on the dock, board the boat and then pick-up the gear.

Boat Loading

The performance of your boat is dependent on load weight and distribution. Passengers should board one at a time and should distribute themselves to maintain trim. Remember to distribute weight from right to left, and also from front to back.



WARNING



All passengers should be carefully seated and not be riding on the deck, gunwale, rear sun deck, or elevated pedestal fishing seats while underway. Passengers riding in the bow rider seats should exercise extreme caution. During rough water operation, passengers in the bow rider seats should move to the aft passenger seats.

- Do not allow your passengers to ride with their feet dangling over the side, floating debris can cause serious injury.
- Avoid excess weight in the bow or stern.
- Securely stow all extra gear in stowage areas to prevent load shifting. Do not stow gear on top of safety equipment; safety equipment must be quickly accessible.
- In adverse weather, reduce the load in the boat. People/load capacity ratings are based upon normal boating conditions.
- Do not use the engine unit as a boarding ramp. Make sure engine is off when swimmers, divers, and skiers are boarding to prevent injury.

Capacity

Boats up to 26' in the National Marine Manufacturers Association (NMMA) program have a maximum rated load capacity, which is stated on the certification plate (if so equipped). The load capacity of boats under 20' are determined by the USCG. The person/load capacity is determined by various USCG formulas. Actual capacity is determined by the availability of proper seating on the boat. Acceptable seating determines the number of passengers, not the overall load capacity.

U.S. COAST GUARD	
MAXIMUM CAPACITIES	
8 PERSONS OR 1150 LBS.	
1600	LBS. PERSONS, (MOTOR) GEAR
140	H.P. MOTOR
THIS BOAT COMPLIES WITH U.S. COAST GUARD SAFETY STANDARDS IN EFFECT ON THE DATE OF CERTIFICATION	
MANUFACTURER: _____	
MODEL: _____	
DESIGN COMPLIANCE WITH NMMA REQUIREMENTS BELOW IS VERIFIED. MFGR. RESPONSIBLE FOR PRODUCTION CONTROL.	
LOAD CAPACITY • COMPARTMENT VENTILATION STEERING, FUEL AND ELECTRICAL SYSTEMS INTERNATIONAL LIGHTS • BASIC FLOTATION MANEUVERABILITY	
	NATIONAL MARINE MANUFACTURERS ASSN.

OUTBOARD
POWERED
BOATS ONLY

Note

The capacity plate for outboard powered boats lists the maximum horsepower that the boat can safely use. It is unlawful to overpower a boat.



WARNING



Do not exceed the USCG certified maximum capacities under any circumstances. Overloading will reduce freeboard and increase the likelihood of swamping, especially in heavy seas. Overloading causes handling to become sluggish making it hard to react quickly.

Overpowering outboard powered craft is extremely dangerous. Overpowering will make the boat unstable and could cause loss of helm control.

KC-1440

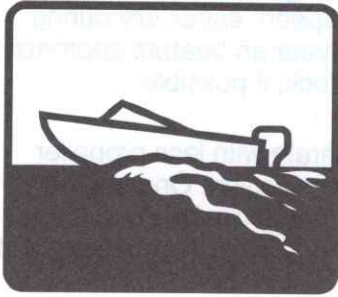

6

RUNNING

We urge you and all others operating the boat to seek certified instruction from the local boating authorities.

This section is designed to present the most basic operational principles. It is NOT intended to cover all conditions encountered during operation. The principles presented in this manual are limited directly to the operation of the boat. The responsibility for the proper application of these principles belongs to you.

MANEUVERING TECHNIQUES

Steering response depends on three factors: engine position, motion and throttle.

STERN
CIRCLE

BOW
CIRCLE

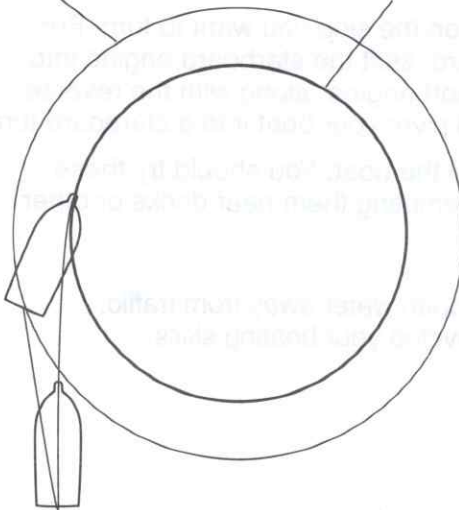

Like an automobile, high speed maneuvering is relatively easy and takes little practice to learn. Slow speed maneuvering, on the other hand, is far more difficult and requires time and practice to master.

When making tight maneuvers, it is important to understand the effects of turning. Since both thrust and steering are at the stern of the boat, the stern will push away from the direction of the turn. The bow follows a smaller turning circle than the stern.

KC-1473

The effects of unequal propeller thrust, wind, and current must also be kept in mind. While wind and current may not always be present, an experienced boater will use them to his advantage. Unequal thrust is an aspect shared by all single engine propeller-driven watercraft. A clockwise rotation propeller tends to cause the boat, steering in the straight ahead position, to drift to starboard when going forward, and to port when going backward. At high speed, this effect is usually unnoticed, but at slow speed; especially during backing, it can be powerful. For this reason, many veteran boaters approach the dock with the port side of the boat toward the dock, if possible.

Twin-engine craft with counter-rotating engines operate with less propeller torque induced drifting, using the concept of counter rotation. One engine propeller turns clockwise while the other turns counterclockwise. This helps maintain an even keel by eliminating the tendency of your dual-powered boat to veer.

Stopping (checking headway) is a technique that must be developed. Since a boat has no brakes, reverse thrust is used to slow and stop the boat. The momentum of the boat will vary according to the load as well as the speed. Make it a practice to slow to idle (no-wake) speed before shifting into reverse.

Twin Engine Maneuvering

One thing to keep in mind when maneuvering with twin engine powered boats at low speeds, is that turns are made by thrusts of power from the engines and propeller, not by turning the outdrive unit. This means at lower speeds, steering your boat becomes a combination of propeller direction, engine thrusts, and steering wheel maneuvers.

To make sharp and close quarter turns, observe the following:

- Before attempting to make close turns at low speed, bring the throttles to idle so you can shift into reverse without damaging the engine.
- Reverse the direction of the engine on the side you want to turn. For example, if you want to turn starboard, shift the starboard engine into reverse. The forward speed of the port engine, along with the reverse rotation of the starboard engine, will pivot your boat into a starboard turn.
- Practice using the throttles to control the boat. You should try these maneuvers in open water before attempting them near docks or other boats.

It is best to learn maneuvering skills in open water away from traffic. Adequate practice is the only way to develop your boating skills.

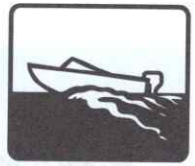

SALT WATER

If boat is moored in salt water for long periods, tilt the engine out of the water (except during freezing temperatures). After removing the boat from the water, lower the engine to the run (down) position until the cooling system has drained thoroughly. Hose the entire hull down with fresh water and wipe dry.

Today's engines are built for operation in either fresh or salt water. Fresh water internal flushing is not normally required, however, it may be desirable after use in salt, polluted, or brackish water. Your dealer will assist you in obtaining the appropriate engine flushing device.

FREEZING TEMPERATURES

When the boat will be operated and left in the water and temperatures drop below freezing, the engine must remain in the tilted down (submerged) position at all times to prevent water in the engine from freezing. When the boat is removed from the water, drain the engine completely.

TOWING PROCEDURE

If seas are rough, it may not be easy to extend the tow line from one boat to another. In these cases, use a light throwing line with a weight on one end and with the heavier towing line secured to it.

Never attempt to tow a much larger or grounded vessel. Because of the tremendous stress caused by towing, use a tow line that is rated at least 4 times the gross weight of the boat being towed. Tow ropes must always be in good condition, free of any cuts or abrasions.

Attach tow line to the bow eye on the disabled boat. Attach the opposite end of the bridle only to the stern eyes of the tow boat. Wrap the bridle with chafing gear where it rubs against the boat or any corners. Leave at least 2 boat lengths between the boats for adequate movement.

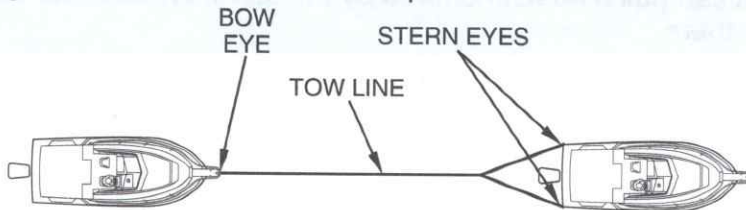

KC-2114



WARNING



When towing, use only the bow and stern eyes; never use cleats, handrails, etc. Do not allow anyone to be in line with the tow rope. If the rope should break or pull free, a dangerous recoil could occur which may seriously injure or kill anyone in its path.

Adjust the tow line to match wave action. Keep the boats on the crest or in the trough of the waves at the same time. In protected, calm waters, shorten the line for better handling. Always tow at moderate speed, allowing for adverse wind and wave conditions. Have the operator of the towed boat steer with you if possible.

If you need a tow, or wish to tow another boat, use great care. The boat structure can be damaged by excessive pulling strain. You should always offer help to a boat in trouble. However, towing a capsized, grounded, or hull damaged boat is dangerous. Give assistance to the occupants; then call the proper authorities.

ANCHORING

Dropping Anchor

There are many types of anchors available on the market. The choice of one anchor over another depends on many factors. An anchor will usually hold best in a mixture of mud and clay or in hard sand. A lightweight Danforth anchor is recommended for general boating. For more information on anchors consult your dealer.

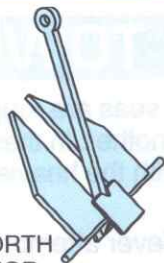

DANFORTH
ANCHOR

KC-1571



CAUTION

Always anchor from the bow; NEVER anchor from the stern. A small amount of current will make the boat unsteady...a strong current can pull a boat, anchored by the stern, under water and keep it there.

RUNNING

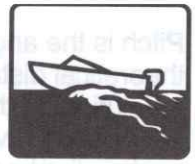

When anchoring, it is helpful to keep a few guidelines in mind.

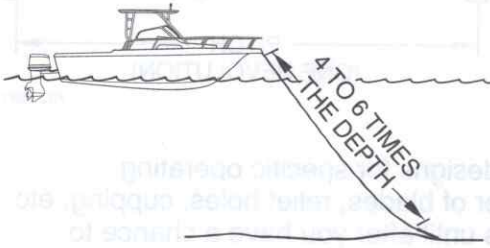

KC-1536

- Make sure the line is tied to the anchor and tie the other end of the line to the forward cleat or bow eye.
- Head the boat into the wind or current over the spot where you want to lower the anchor.
- Stop the boat before lowering the anchor.
- When the anchor hits bottom, slowly back up the boat, keeping tension on the line. Let out an anchor line that is 8 to 10 times the depth of the water. For example, if you are in 10 feet of water, let out 80 to 100 feet of line.
- Secure anchor line to the bow cleat. Pull on line to make sure anchor is holding.
- Occasionally check your position against the shoreline. If the anchor is dragging and you are drifting, reset the anchor.

Weighing (Pulling In) Anchor

Start engine and move forward until anchor line is straight up and down. Pull hard to lift anchor from the bottom material.

If the anchor is stuck, attach anchor line to the bow cleat so that it is taut. The up and down motion of the bow from wave action may lift the anchor from the bottom. If the anchor remains stuck, let out a few more feet of line and attach it to the bow cleat. Slowly maneuver the boat around the anchor until the anchor pulls. Be sure to keep the line tight during this procedure.

PROPELLERS

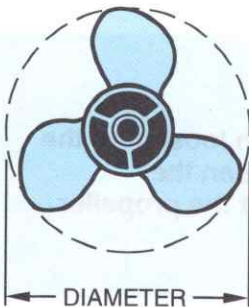

KC-1580

The propeller converts the engine's power into the thrust needed to propel the boat. Care and selection of your propeller is very important to proper boat operation. Propellers are identified by two numbers, such as 13 x 19, and a material identification, such as aluminum or stainless steel. In the number sequence, the first number is the diameter of the propeller and the second is the pitch.

Pitch is the angle of the blades expressed in the theoretical distance a propeller travels in each revolution. In the above example, the pitch is 19, or each revolution of the propeller pushes the boat 19 inches through the water. A 19" pitch is considered "higher" pitched and a 15" propeller is considered "lower" pitched.

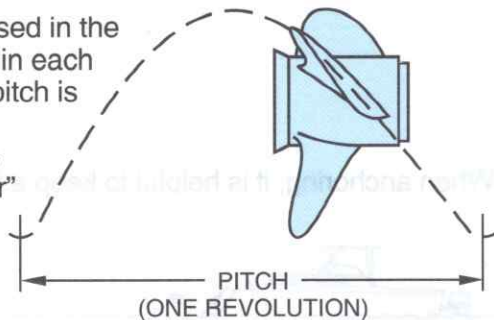

KC-1581

Keep these guidelines in mind when selecting a propeller:

- There are many different propeller designs for specific operating characteristics, including the number of blades, relief holes, cupping, etc. Do not attempt to change propellers until after you have a chance to determine your average load and individual requirements. Your dealer is best qualified to help you select a propeller.
- Engine RPM must be within the recommended operating range. Refer to the engine operator's manual.
- Higher propeller pitch reduces: RPM, acceleration, engine noise, and usually improves fuel economy and top speed.
- Lower propeller pitch increases: RPM, acceleration, engine noise, reduces fuel economy and top speed.



WARNING



Before installing or removing the propeller:

- Put the remote control in the "NEUTRAL" position.
- Put the main switch in the "OFF" position and remove the key.

A smaller pitch propeller should be selected for water skiing or for heavy loads. A smaller pitch propeller will develop more thrust for faster planing. A higher pitch propeller should be selected if full throttle RPM exceeds the maximum recommended range.



WARNING



DO NOT use your hand to hold the propeller when loosening the nut. You could be injured. Put a wood block between the cavitation plate and the propeller blade to prevent the propeller from turning.

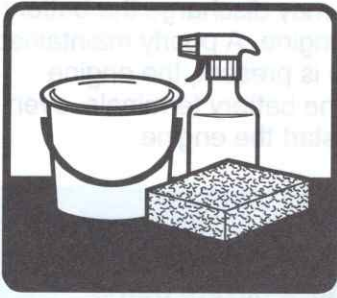

7

CARE AND MAINTENANCE

This section describes how to care and maintain your boat. It includes information about maintaining electrical components, corrosion protection, and general maintenance.

ELECTRICAL

Battery

The boat is equipped with a 12-volt direct current (12 VDC) negative ground electrical system. The positive (red) wire is hot and feeds current from the battery to the electrical systems. The negative (black) wire is ground and completes the circuit back to the battery. Until the engine is running at high idle or faster, all electrical power comes from the main battery. Once the engine is started and running above 1200 rpm, electrical power is then provided by the engine alternator. The alternator provides more power as engine speed is increased. When the engine is operating, the alternator is charging the battery.

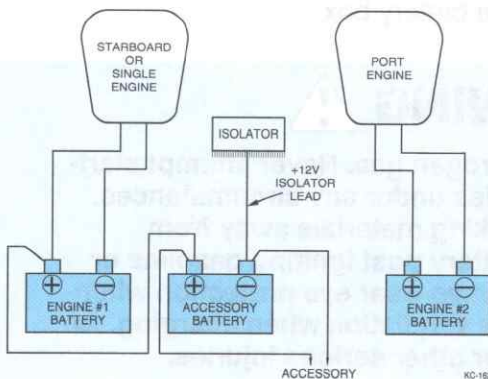

Some models are equipped with a battery isolator that will automatically charge an accessory battery when the engine is running. The isolator automatically isolates each battery so that the lower charged battery will be charged first and the full battery cannot discharge to the drained battery. A battery selector switch may also be included for flexibility of use such as selecting either battery for starting, paralleling batteries, etc.

More electrical accessories than ever are being used on today's boats. Continuous operation of electrical accessories when the engine is not operating, or operating at low idle (trolling) speeds may discharge the battery to the point where it may not be able to crank the engine. A poorly maintained battery will discharge more quickly, and if corrosion is present, the engine might not start due to high electrical resistance at the battery terminals, even though there may be sufficient battery reserves to start the engine.

WARNING

Batteries contain sulfuric acid which can cause severe burns. Wear protective clothing to avoid acid contact with skin, eyes, etc.

Check the battery frequently for signs of corrosion. If corrosion is evident, clean terminal posts with a baking soda and water solution and a wire brush. Before cleaning, remove the vent caps and seal the vent wells with corks to prevent the solution from getting inside the battery. Also, check the fluid levels in the cells. Usually, a level approximately 1/4 to 1/2 inch above the plates is sufficient. If needed, fill with distilled water; do not overfill! Some batteries are sealed, and cannot be filled.

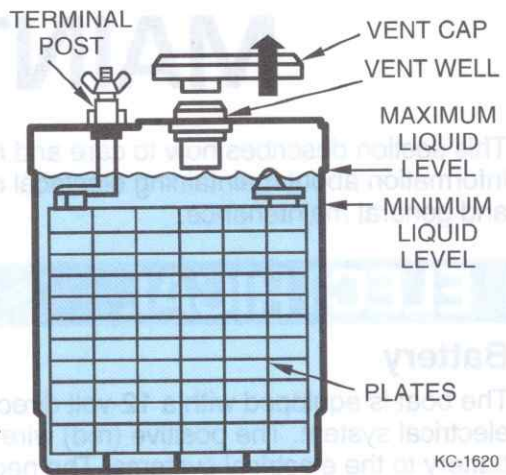

Batteries are perishable products and will self-discharge. If you operate your boat sparingly, you may want to charge your battery occasionally. To recharge, remove the battery from the boat and remove the battery caps (when applicable). Recharge the battery according to the directions enclosed with your battery charger. When installing the battery in the boat, make sure the battery is secured in the battery box.

WARNING

Batteries produce explosive hydrogen gas. Never attempt starting your engine with jumper cables under any circumstances. Keep all sparks, flames and smoking materials away from batteries. Risk of spark at the battery post igniting gasoline or hydrogen fumes is too great. Always wear eye protection when near batteries and have adequate ventilation when charging. An explosion can cause blindness or other serious injuries.

CARE AND MAINTENANCE



Circuit Breakers and Fuses

All electrical circuits are protected from overload by the use of circuit breakers. In the event of an overload or short circuit, the circuit breaker will trip. If a circuit continuously overloads under normal operating conditions, have your boat inspected by the dealer immediately.



CAUTION

Never exceed the recommended fuse sizes or bypass the fuse safeguard. Always install the proper (type and rating) fuses whenever replacing or changing fuses. Continuous fuse/breaker failures indicate a severe problem that requires immediate attention. Failure to install correct fuse may result in damage to the electrical system or severe personal injury.

Some boat models have each individual circuit protected with a circuit breaker located next to the switch. To reset a tripped circuit breaker, switch OFF the circuit, wait about one minute for the breaker to cool, push the breaker button fully, and switch ON the circuit.



CAUTION

The electrical system is designed to protect you from short circuits and overload. Any modifications to the system, such as adding electrical accessories, should be done by a qualified technician.

Some installed accessories, such as the stereo, have an additional fuse located in the positive lead of the stereo. Some in-line fuse holders can be found near the battery.

TYPICAL IN-LINE FUSE HOLDER



(TWIST AND PULL TO OPEN)

KC-1640

CORROSION PROTECTION

Galvanic Corrosion

Galvanic corrosion (electrolysis), to the boater, is the break-up of metals due to the effects of electrolytic action. When two dissimilar metals are immersed in a conductive fluid (salt water), an electric current is produced, much like a battery. As the current flows, it takes with it tiny bits of the softer metal. If not stopped, a great deal of damage could occur.

If you operate in salt, polluted, or brackish waters, your boat should be equipped with a transom mounted zinc anode to prevent damage to those metal parts coming in contact with the water. The zinc is, by design, self-sacrificing. It is slowly eroded away by electrolytic action and requires periodic inspection for deterioration. If the zinc shows extreme erosion, it must be replaced to continue protection, or damage to other metal parts may result.

Most engines are equipped with one or more zinc anodes which must also be inspected regularly for deterioration. Some boat models may be equipped with an electronic cathode system. This system emits a low current electrical charge into the water close to the metal components. This charge cancels the effect of electrolysis.

CAUTION

Never paint or coat zinc anodes or cathodes with any substance. Once covered, they do not provide protection from galvanic corrosion. Replace anodes if they have deteriorated 50% or more.

Salt Water Corrosion

The entire boat should be rinsed with fresh water and washed immediately after use in salt water. If the boat is used primarily in salt water, wax the hull monthly and apply corrosion inhibitor to all hardware. See your dealer for products suitable for the marine salt water environment. Fresh water internal flushing is recommended when used in salt, polluted, or brackish waters. Flush the entire engine cooling system with fresh water for at least 5 minutes after use in these waters. See your dealer for appropriate flushing devices.

CARE AND MAINTENANCE



GENERAL MAINTENANCE

Marine Growth

If accelerated marine growth is a problem in your area, an anti-fouling bottom paint may be necessary to slow growth and prevent gelcoat damage. Before selecting a bottom paint, talk with other boaters and your dealer to determine which product works best in your area. Many local variables can affect the selection of paint. Be sure to follow the paint manufacturer's directions exactly.

Cleaning

Periodic cleaning is the best way to keep your boat looking new. Regular washing and waxing keep dirt and scum from building up and deteriorating the finish. Keeping your boat in "show room" condition means greater personal satisfaction and higher resale value. Special cleaning products are available from your dealer to remove mildew.

Hull

When washing the boat, be sure to use a mild detergent and warm water solution. DO NOT use abrasive cleaners, solvents, ammonia or chlorine as these will damage the gelcoat surface. Under extreme conditions, special cleaners may be used to remove marine growth, such as scum or algae, from the hull; see your dealer.

Waxing the entire gelcoat surface at least twice a season is recommended for all climates. Use of a specially formulated marine gelcoat wax will prevent color fade and soil and scum adhesion. If the gelcoat has chalked or faded from lack of proper maintenance, buffing may be necessary to bring back the shiny appearance. Hand buffing with #7 rubbing compound or power buffing with glazing compound #1 will quickly restore the surface.

Upholstery

Regular washing with mild detergent and warm water or automotive vinyl cleaners is sufficient to keep the cushions, canopy top, and vinyl coverings in good condition. Keep the cushions from becoming soaked and dry off thoroughly after washing to prevent mildew accumulation after the boat is covered. Prop the cushions up in the boat when covered to allow air circulation and spray with mildew repellent. Lubricate canopy top snaps with petroleum jelly.

Stain	Steps		
	1	2	3
Ballpoint Ink*	A	B	E
Chewing Gum	D	A	B
Coffee, Tea or Chocolate	B		
Fish Scent*	A	B	E
Grease	D	B	E
Ketchup	A	B	
Latex Paint	A	B	E
Mildew or Wet Leaves*	C	A	B
Motor Oil	B		
Paint, Oil Base (Dried)	D	A	B
Paint, Oil Base (Fresh)	D	B	E
Permanent Marker*	B	C	E
Shoe Polish*	D	B	E
Soil	A	B	
Spray Paint	B	E	
Suntan Lotion	A	B	E
Tar/Ashpalt	D	A	B
Yellow Mustard	A	B	C

*These products contain certain dyes that stain permanently.

Treatment

- A. Medium soft brush-warm soapy water.
- B. Household spray cleaner (Fantastic).
- C. One (1) tablespoon bleach to one (1) quart water.
- D. Wipe or scrape off excess. (Chill gum with ice.)
- E. Follow instructions of staining agent manufacturer.

CARE AND MAINTENANCE

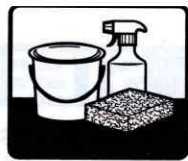

CAUTION

Certain automotive, household and industrial cleaners can cause further damage and discoloration. Solvents and dry cleaning fluids, or products that contain dyes such as waxes, should be used with caution. Whenever cleaning stubborn stains, be sure to test the treatment in an unseen area first. The following stain treatments should be used with discretion. Between steps, be sure to rinse thoroughly with plenty of clean water and allow to dry.

Windshield

A clean windshield is important. The windshield requires special cleaning to prevent scratches to the surface. Use a mild soap solution and damp cloth only. Harsh detergents, solvents, chemicals or dry cloths will scratch the surface.

Bilge

Your bilge accumulates oil and greasy dirt over a period of time and should be cleaned out. Usually, ordinary soap and water does not remove the accumulation, and something stronger is necessary. Consult your dealer for recommendations on special bilge cleaning products.

Stainless Steel and Chrome

Stainless steel and chrome plated parts are not totally resistant to corrosion. Occasional cleaning and polishing with a marine chrome and stainless polish will maintain and extend the useful life. In salt water areas, rinse all hardware with fresh water and apply a light coating of corrosion inhibitor oil to enhance appearance.

FUEL SYSTEM

Fuel lines, vent hoses, and drain hoses should be checked frequently for leaks. Some models are equipped with removable inspection plates for fuel system component inspection. If a leak occurs around the fitting, then tightening of the hose clamps may be all that is necessary. However, if the leak continues, replace the hose immediately to prevent a build-up of fluids or gases. Surface cracking on the hose indicates wear, and replacement is recommended. Use fuel system parts certified for marine use only; do not substitute automotive parts in marine application.

STEERING SYSTEM

The steering system is the primary link for engine control and must be inspected and maintained regularly. The hardware at both the helm and engine end of the steering cable must be checked frequently for tightness. Refer to the engine operator's manual for the appropriate torques. On hydraulic systems, check fluid level in reservoir. Make sure all hoses are tight and do not leak.

The steering bar must be lubricated monthly to ensure smooth operation. Turn the steering wheel to a full starboard turn to expose the bar. Use a high quality waterproof marine grease and fully coat the bar. Turn the steering wheel back and forth to work the grease in.

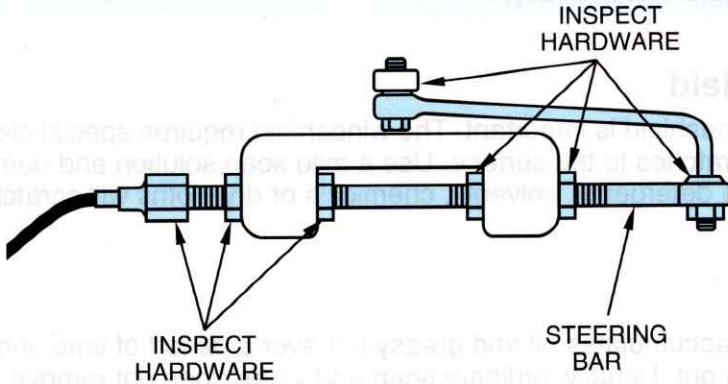

TYPICAL ENGINE STEERING LINK

KC-1645

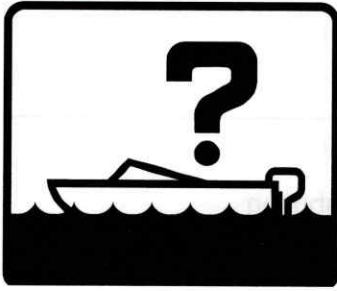

8

TROUBLESHOOTING

The following chart will assist you in finding and correcting minor mechanical and electrical problems. If an engine problem is indicated, consult your engine owner's manual.

Some problems may require specialized skill and tools to correct them; see your dealer.

TROUBLE CHECK CHART

Symptom	Possible Cause
Engine will not crank	<ul style="list-style-type: none">● Emergency safety switch not connected● Throttle/shift control in gear● Main circuit breaker open● Battery terminals corroded● Weak battery● Loose or corroded battery wiring connections● Engine problem
Engine cranks but will not start	<ul style="list-style-type: none">● No fuel in tank● Fuel filter clogged

Symptom	Possible Cause
Engine cranks but will not start (cont.)	<ul style="list-style-type: none"> ● Contaminated fuel ● Engine problem
Poor boat performance	<ul style="list-style-type: none"> ● Contaminated fuel ● Uneven load distribution ● Engine trim wrong ● Improper propeller selection ● Excessive water in bilge ● Engine problem
Poor gas mileage	<ul style="list-style-type: none"> ● Plugged flame arrestor (stern drive) ● Engine trim wrong ● Marine growth on hull ● Engine problem
Throttle/shifting problems	<ul style="list-style-type: none"> ● Corroded cable ● Kink in cable ● Engine problem
Excessive vibration	<ul style="list-style-type: none"> ● Propeller damaged or fouled ● Engine problem
Electrical problems	<ul style="list-style-type: none"> ● Open circuit ● Loose wiring connections ● Defective switch or gauge

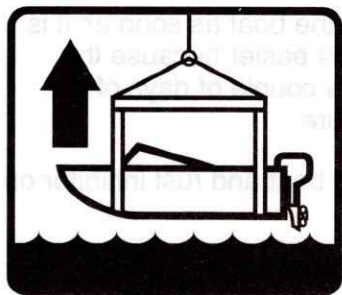

9

STORAGE

Storage or winter lay-up requires special preparation to prevent damage to the boat. Perform all annual maintenance at this time.

Without proper preparation, storage for long periods of time may cause internal parts of the engine and drive unit to rust because of lack of lubrication. Or, if the boat is stored in below freezing temperatures, water inside the bilge or cooling system may freeze causing damage. Damage to the boat due to improper storage will not be covered by the warranty. The following procedures should help prevent damage to your boat.

While The Boat Is Still In The Water

1. Fill fuel tank and add the proper amount of fuel stabilizer and conditioner according to the manufacturer's recommendations.
2. Operate boat for at least 15 minutes to be sure that treated fuel has reached engine.

Note

If the boat is to be stored for more than 5 months, stored in a high moisture (humidity) environment, in temperature extremes, or stored outdoors, "fog" the engine with a rust preventative fogging oil according to the manufacturer's recommendations. See your dealer.

When The Boat Is Removed From The Water

Note

Remove the bilge drain plug immediately after taking the boat out of the water. After washing, raise the bow of the boat high to allow as much water as possible to drain while performing other storage preparations.

- Flush the engine cooling system with clean water. DO NOT exceed 1500 rpm when flushing.
- Perform all scheduled maintenance. For stern drives, tuning the engine and changing the oil and fuel filters (if equipped) is especially important.
- Thoroughly clean the hull, deck and interior of the boat as soon as it is removed from the water. Cleaning at this time is easier because the marine growth is still wet. Be sure to allow for a couple of days of air drying to prevent mildew due to trapped moisture.
- Apply a coat of wax to the entire surface of the boat and rust inhibitor on all metal parts.
- Clean all traces of dirt, oil, grime, and grease from the engine and bilge. Touch-up areas of engine where paint has been removed.
- Prepare the engine for storage according to the instructions contained in the engine owner's manual.
- Store the bilge drain plug in a plastic bag and tape it to the throttle control lever so that it is easily found for reactivation.
- Remove the batteries from the boat. Clean, fully charge and store the batteries in an area not subject to freezing temperatures. Never store batteries close to heat, spark, or flame producing devices.
- Repack trailer wheel bearings with water resistant wheel bearing grease. If the trailer is equipped with bearing protectors, squirt grease into hubs with a grease gun.
- Park trailer and boat in a protected area. If the rig is left outside, install a boat cover. See your dealer.
- Loosen tie-downs and winch line but be sure the boat is resting properly on hull supports.
- Jack up trailer and place blocks under trailer frame to relieve weight on trailer tires and springs.

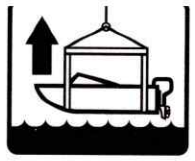

Reactivating The Boat After Storage

- Charge and install batteries in boat.
- Check engine and bilge for signs of nesting animals; clean as necessary.
- Check entire engine for cracks and leaks caused by freeze damage.
- Check hose condition and all hose clamps for tightness.
- Install bilge drain plug.
- Perform daily maintenance. If not performed during lay-up, perform annual maintenance.
- If the boat is equipped with the optional fresh water cooling system (stern drive only) and was drained for storage, fill the system with fresh coolant solution.
- Check and lubricate steering system.
- Remove blocks from under trailer frame.
- Tighten tie-downs and trailer winch line.
- Check tire pressure and lug nuts on trailer.
- Take the boat to the water and start it. It may take a minute of cranking to allow the fuel system to prime. Allow a one minute cool down period for every 15 seconds of cranking. When the engine starts, keep a close watch over the gauge readings and check for leakage and abnormal noises. Keep speeds low for the first 15 minutes until the engine has reached normal operating temperature.

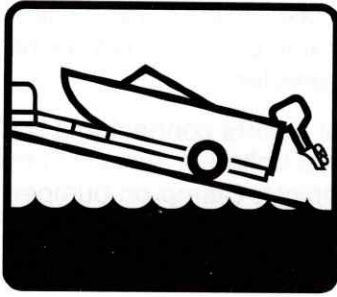

10

TRAILERING

This section provides information about trailering. It describes the hitch and safety chains, backing your trailer, preparing to launch, launching, and loading your trailer. Also included is a trailering checklist.



WARNING



- The trailer must be matched for the boat's weight and hull.
- The towing vehicle must have the capability of pulling the load. Pulling a load that exceeds the vehicle's towing capacity may cause a loss of control.

Note

Check the certification label on the left forward side of your trailer. The label is required to show the Gross Vehicle Weight Rating (GVWR), which is the load carrying capacity plus the weight of the trailer itself. Be sure that the total weight of your boat, engine, gear, and trailer do not exceed the GVWR.

Trailer laws on things such as lighting, registration, trailer brakes, gross vehicle weight, etc., vary widely from state to state. Contact your state Dept. of Motor Vehicles (and that of other states through which you may be traveling) for laws with which you must be in compliance.

HITCH

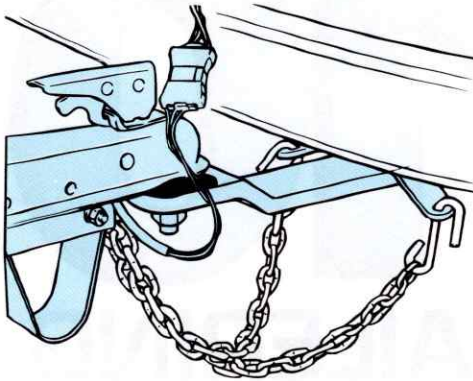

Hitches are divided into classes that specify the gross trailer weight (GTW) and maximum tongue weight for each class. Always use a hitch with the same class number as the trailer, or greater.

Most boat trailers connect to a ball hitch that is bolted or welded to the towing vehicle. Clamp-on bumper hitches are not recommended.

KC-1700

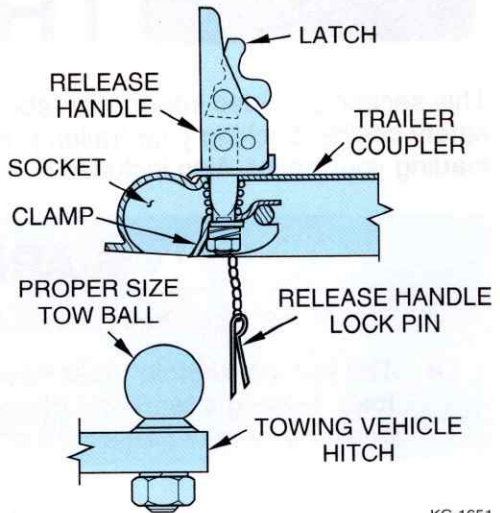

KC-1651

The trailer hitch coupler must match the size of the hitch ball. Never use a hitch ball that does not match the trailer coupler. The correct ball diameter is marked on the trailer coupler.

SAFETY CHAINS

CRISSCROSS SAFETY CHAINS

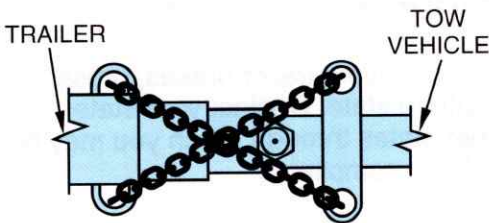

BOTTOM VIEW OF HITCH COUPLING

KC-1691

Safety chains on your boat trailer provide added insurance that it will not become completely detached from the towing vehicle when underway.

Crisscross the chains under the trailer tongue to prevent the tongue from dropping to the road if the trailer separates from the hitch ball. Rig the chains as tight as possible with just enough slack to permit tight turns.

Make sure the proper chains are correctly attached between the towing vehicle and trailer before and during each trip.

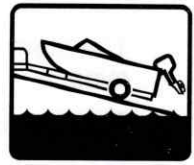

TRAILER BRAKES

In some states, any trailer with a gross vehicle weight rating (GVWR) of 1,500 pounds or more is required to have brakes. Usually, this brake is a self-contained, hydraulic surge system, with either a drum or disk brake. Consult your trailer manufacturer's owner's manual for more information on operation and adjustments.

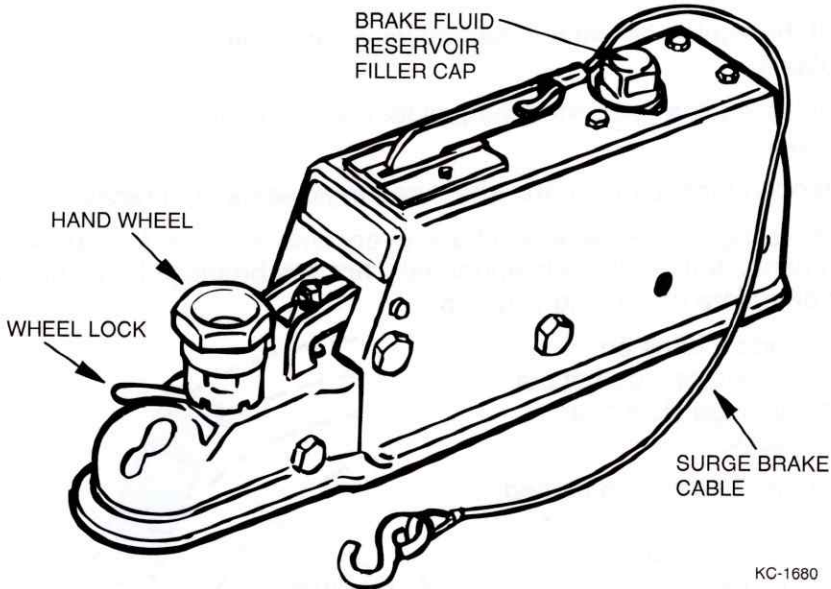

KC-1680

TRAILERING CHECKLIST

Below is a checklist to follow when trailering your boat:

- Consult your state laws as to brake and axle load requirements. Check brakes for proper operation and fluid level prior to departure on each trip.
- Check springs and undercarriage for loose parts.
- Check tires for proper inflation. Under-inflated tires heat up rapidly and tire damage or failure is likely to occur.
- Wheel bearings and lug nuts should be checked before each trip.
- Your boat should be fastened to the trailer by a line from the bow eye to the winch line PLUS a bow tie-down to the winch stand or trailer tongue.

The stern of your boat should be tied down to the trailer from the stern eyes.

- Check to be sure the taillights and turning signals work prior to towing.
- Too much or too little tongue weight will cause difficult steering and will make tow vehicle sway. A rough rule of thumb is 5% to 10% of boat and trailer weight on the tongue.
- Convertible tops are not designed to stay on boats at highway speeds. Before towing, take down the convertible top, side curtains, and back cover.
- Carry a spare tire for both your trailer and your towing vehicle along with sufficient tools to change them.
- Consult the engine operator's manual for engine related trailering precautions.
- Consult the engine operator's manual for engine related trailering precautions.
- On extended trips, carry spare wheel bearings, seals, and races.
- While traveling, check the wheel hubs every time you stop for gas or refreshments. If the hub feels abnormally hot, the bearing should be inspected before continuing your trip.
- When rounding turns on highways or streets, do not cut corners. Also, go slow over railroad tracks.
- Outboard motors should be tied in place so they will not tilt or turn due to road shock. Continuous road shocks may fatigue the boat steering system.
- Before backing your trailer into water, disconnect the light plug from the towing vehicle to reduce the likelihood of blowing out lights when they become submerged.

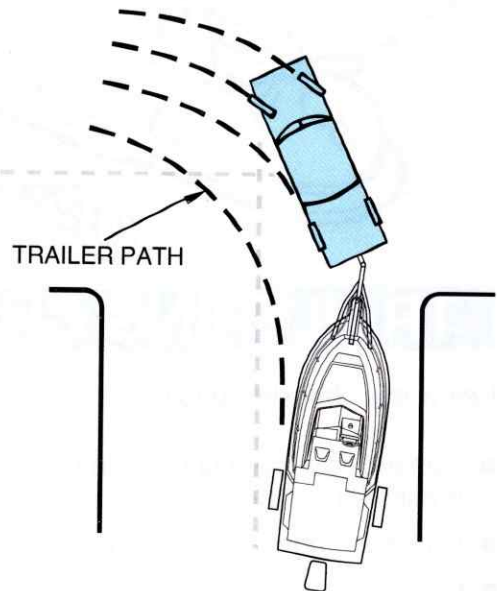

KC-1735

TRAILERING

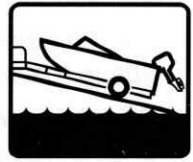

BACKING UP TRAILERS

If you have never towed a trailer before, take the time to practice backing your trailer before using it for the first time. Follow these guidelines when backing:

- Back slowly and make small steering adjustments.
- Turn the car wheels in the opposite direction you want the trailer to go.
- After the trailer begins moving, turn the car to follow it.
- Have a second person assist you with hand signals.

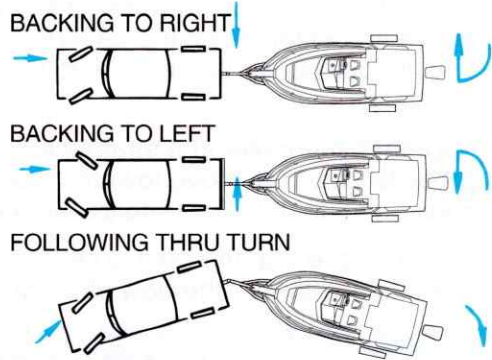

KC-1765

LAUNCHING

Before launching your boat, stay to one side and watch a couple of launchings to notice any problems on the ramp and the effects of the wind and current on launching. It is a common courtesy to prepare the boat for launching away from the ramp especially during busy periods. Perform the pre-launch sequence as follows:

1. Remove the boat cover, if equipped.
2. Check that bilge drain plug is in place.
3. Remove any additional trailering tie-downs from the boat.
4. Attach the bow and stern docking lines and fenders if necessary.
5. Disconnect the trailer lights from the car.

Launching with two people is recommended. Since all launches are different from each other in some way, the following procedure must be modified to fit the launch in use:

1. Back the boat down the ramp until the wheels are at least halfway submerged. Keep the trailer/car combination as straight as possible and at 90 degrees to the shore line.
2. Loosen and detach the bow strap from the bow eye.

3. Back the boat further down until the top of the fenders are about 2" above the water.
4. Board the boat and start it. If possible, remain on the trailer until the engine has warmed-up.

LOADING

Loading, like launching, is best done with two people:

1. Back the trailer into the water until the top of the fenders are about 3" above the water. Keep the trailer/car combination as straight as possible and, if possible, at 90 degrees to the shoreline. Set the parking brake securely.
2. Approach the trailer in a straight line from at least 5' out. Use "bursts" of propeller thrust to move towards the trailer at the slowest steerable speed. Guide the boat onto the support bunks.
3. Check to see that the boat is centered on the support rails and is headed in a straight line for the bow stop (bumper board).



WARNING



Excessive throttle can cause the boat to travel over the bumper board causing extensive damage to the boat, trailer, and car and could cause severe personal injury.

4. Using a very light touch on the throttle, ease the boat forward until the bow comes to rest against the bow stop (bumper board).



CAUTION

The winch bow strap is merely a means of securing the boat to the trailer and is not intended to winch or pull the boat onto the trailer.

5. Attach and tighten the winch bow strap.
6. Pull the trailer up the ramp and attach any additional tie-downs and connect the trailer light harness.
7. Pull drain plug.



SLINGING/LIFTING

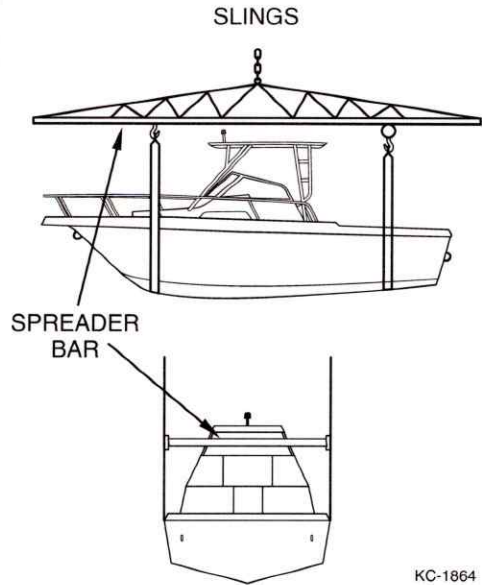
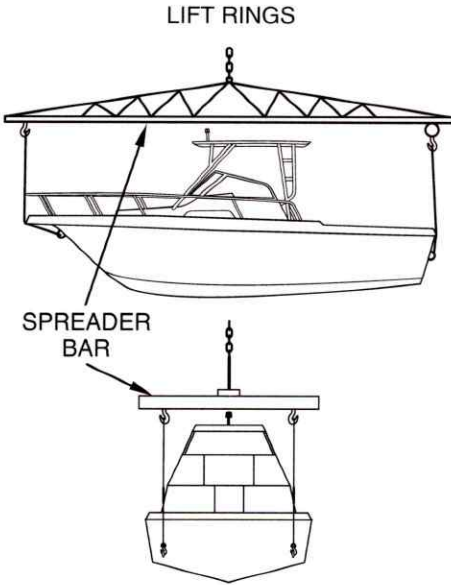

KC-1864

If the boat is to be removed from the water without a trailer, follow these guidelines:

- Never attach lifting cables to cleats, ski tow eyes or hand rails. Attach cables only to the lifting eyes in the transom and bow.
- Cover lifting cables with rubber hose or other protectors to prevent damage to the finish.
- Attach guide lines to the bow and stern to control movement.
- Use spreader bars and keep lifting pressure vertical to prevent side load damage.
- Keep the bow slightly higher than the stern to prevent engine damage.

11

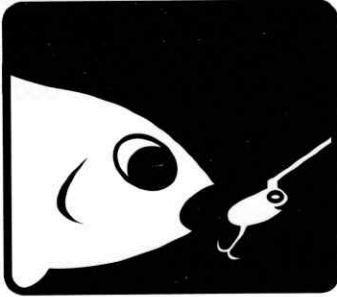

SPECIAL FEATURES

This section describes the special features of your boat. Although your boat may be slightly different from what is presented, the basic operating principles are the same for all types.

Baitwell

Your boat is equipped with one or more baitwells for protection of your bait. Each baitwell is equipped with an aeration pump that oxygenates the water to keep the fish alive. To prevent stagnation of water, empty the baitwell after you are finished using it. Never allow soap or detergents inside the baitwell, residue from cleaners may be harmful to fish.



CAUTION

To avoid freeze damage to the baitwell system, be sure it is completely empty in freezing weather. Water that freezes in hoses will expand and could burst the hose.

This baitwell system aerates the water by continuously pumping freshwater into the well. The spray head breaks the water into many small streams that splash into the water, thereby introducing oxygen into the water. To fill the baitwell; open the valve, and turn the baitwell pump "ON." The water level will be maintained to the height of the overflow. To empty the baitwell; turn "OFF" baitwell pump and remove the drain plug.

Fish Boxes

On some models, the fish boxes are located below the waterline - there is a shut-off valve located under the floor access plate to allow closing of the drain line.

Raw Water System (Washdown - optional)

Models equipped with raw water systems use outside water and have no holding tank. A water intake, usually located in the boat bottom, is exposed to outside water. A valve is positioned inside the boat near the intake. The valve should be in the closed position whenever the raw water or baitwell systems are not being used. The raw water pump pulls outside water through the intake and pushes water to the outlet.

SPECIAL FEATURES

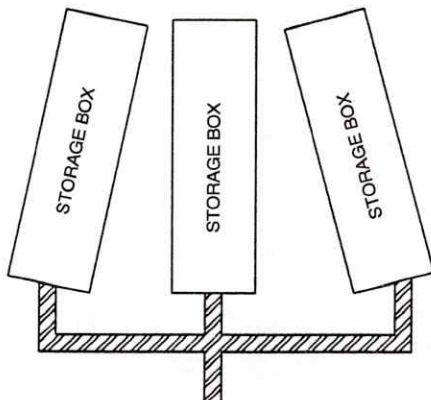
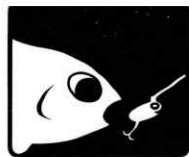

DRAIN INTO BILGE

250C & 230C PLUMBING

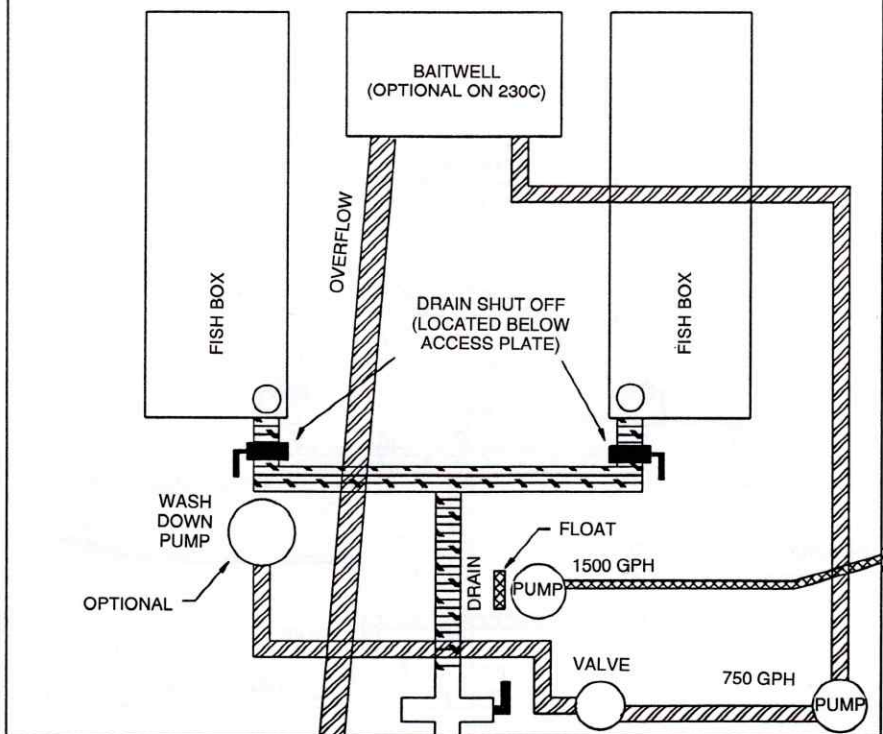

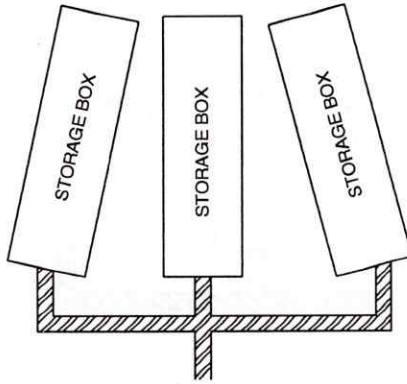

DRAIN INTO BILGE

**210C
PLUMBING**

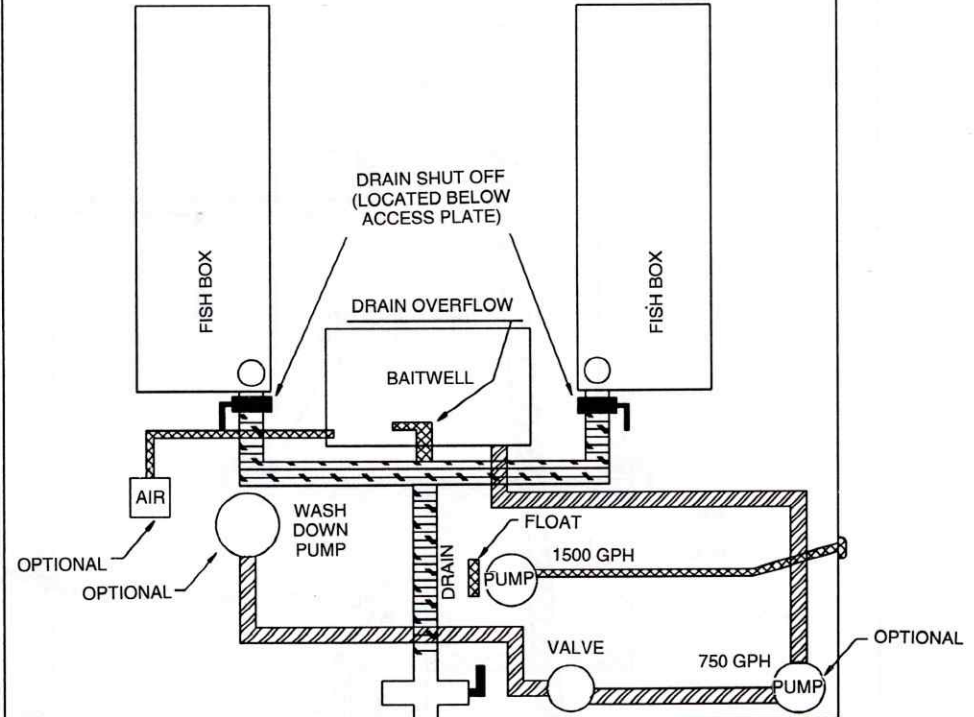

SPECIAL FEATURES

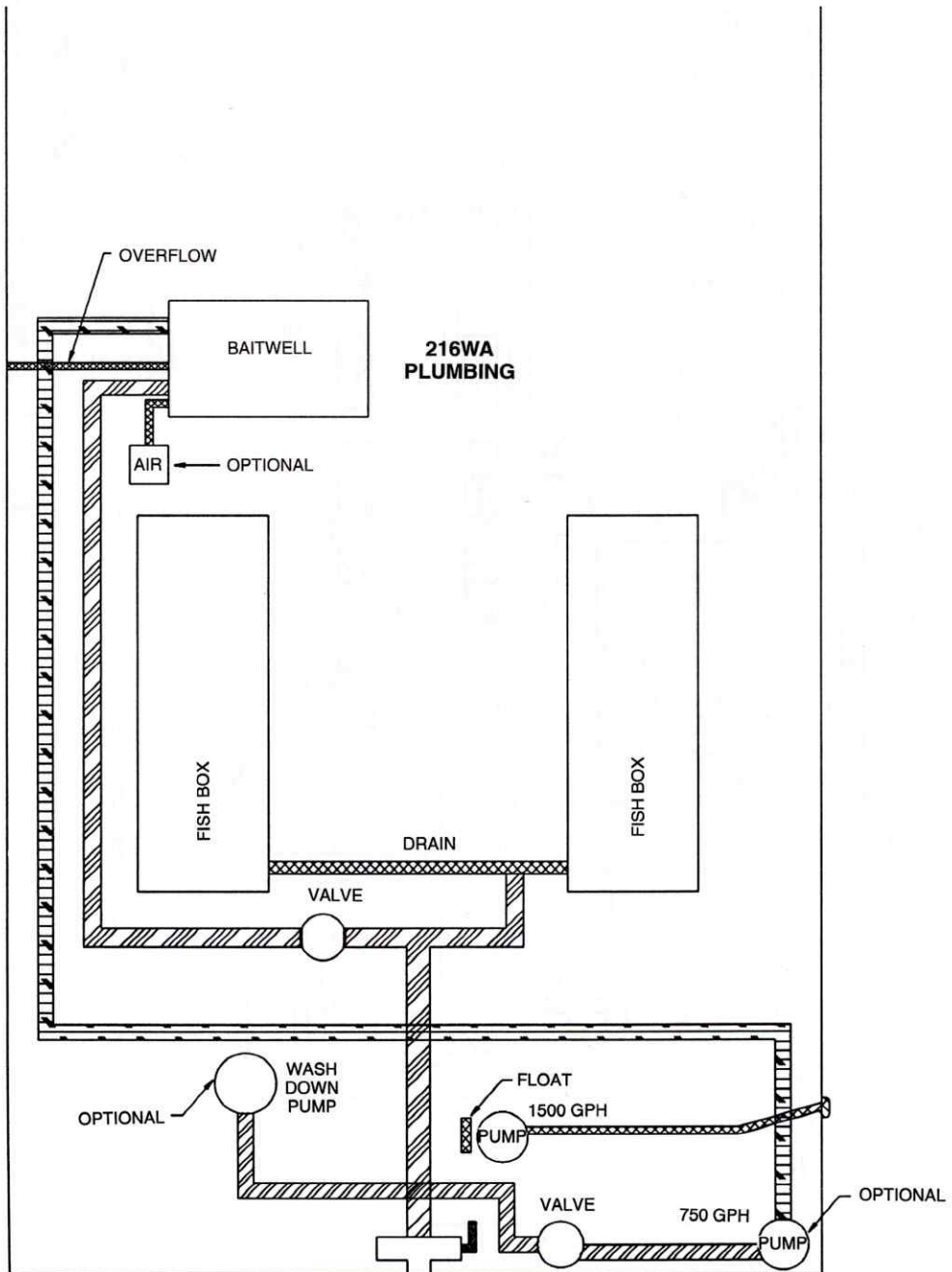
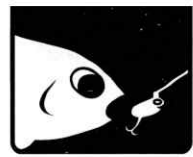

Steering

The 250C, 230C, 216WA, 210C and 184 Flats have hydraulic steering as standard. This is a low maintenance system designed to help control steering torque felt at the wheel.

Correct fluid level must be maintained for proper operation of this system. Fluid level is checked through the cap on top of the helm.

Periodically check fittings and connections for leaks. Check hoses for splits or abrasions. If any are detected, contact your dealer immediately. Refer to the steering manufacturers instructions for proper set and maintenance.



WARNING



Failure to maintain proper fluid levels will result in loss of steering - causing equipment damage and/or serious bodily injury.

The 180C is equipped with Rotary/Cable No Feed Back steering. This system is designed to help reduce steering torque felt at the wheel. However, this is not to be used or to be interpreted in any way as an "Auto Pilot". A firm grip on the wheel is required at all times.

Accessory Mounting

All models are equipped with specific areas of the deck reinforced for the addition of accessories, such as down riggers. Before mounting any accessories in your boat, be sure to consult with your dealer.

WOOD MANUFACTURING COMPANY, INC.

RANGER® BOATS AND RANGER TRAIL® TRAILERS

LIMITED WARRANTY

Wood Manufacturing Company, Inc. ("Wood") expressly warrants that each of its Ranger® Boats and Ranger Trail® Trailers are free from defects in material and workmanship under normal operating conditions. The duration of this limited warranty is (A) One (1) year from date of purchase by the original (first) purchaser as to Ranger® Boat and Ranger Trail® Trailer. (B) Five (5) years from date of purchase by the original (first) purchaser (transferable to subsequent purchasers as to the unexpired portion) as to structural members comprising the hull section of each Ranger® Boat. This limited warranty is subject to the following terms and conditions.

Wood's sole obligation and the Buyer's sole and exclusive remedy against Wood for breach of the express warranty shall be for the repair or replacement of defective parts, free of charge to the Buyer.

To validate this Limited Warranty, the registration card must be completed and returned to Wood within ten days from original purchase. No warranty claim will be considered unless the registration card is in our file.

Under the Limited Warranty, Wood shall have no obligation and the Buyer shall have no remedy against Wood for any other damages including, but not limited to, incidental or consequential damages, direct or indirect, for lost profits, lost sales, loss of time, injury to person or property or for any other incidental or consequential loss from any cause or otherwise, and whether or not occasioned by Wood's negligence.

Repairs will be made by Wood at its factory or Wood may authorize a dealer in your area to make the repairs. Transportation to and from Wood's factory shall be at the Buyer's expense. Wood shall not be responsible for towing, road service charges or any other transportation.

The warranty for the boat does not apply to the following: (1) engines, outdrives, controls, propellers, or other equipment or accessories carrying their own individual warranties; (2) Gel-Coat cracking, crazing, blistering or fading; (3) installation of engines or accessories which are not authorized by Wood; (4) any Ranger® Boat which has been altered, subjected to misuse, negligence, improper trailering, accident or overpowered (according to recommended engine horsepower on capacity information plate); and (5) windshield breakage.

The warranty for the trailers shall include all original components of the trailer except tires, body paint and those components manufactured by other companies which carry the manufacturer's individual warranty.

THE EXPRESS WARRANTY DESCRIBED ABOVE SHALL BE EXCLUSIVE AND THERE IS NO OTHER WARRANTY OR LIABILITY, EXPRESS OR IMPLIED, ARISING BY LAW OR OTHERWISE AND WHETHER OR NOT OCCASIONED BY SELLER'S NEGLIGENCE. THERE IS NO IMPLIED WARRANTY OF MERCHANTABILITY OR FITNESS FOR A PARTICULAR PURPOSE. THERE ARE NO WARRANTIES WHICH EXTEND BEYOND THE DESCRIPTION ON THE FACE HEREOF. THE ENTIRE CONTRACT IS EMBODIED IN THIS WRITING AND THIS CONTRACT CONSTITUTES THE FINAL EXPRESSION OF THE PARTIES AGREEMENT, AND IT IS A COMPLETE AND EXCLUSIVE STATEMENT OF THE TERMS OF THAT AGREEMENT.

NOTICE: Some states do not allow the exclusion or limitation of incidental or consequential damages and some states do not allow limitation on how long an implied warranty lasts. Therefore, some of the above limitations may not apply to you.

Ranger®

**“Still Built One
At A Time”**

WOOD MANUFACTURING CO., INC.

P.O. Box 179, Flippin, AR 72634

Phone 501-453-2222

4-96-500-979999-1